

INSTALLATION INSTRUCTIONS

64 1/2 - 70 MUSTANG,

HEIDTS™ IFS, PRO-G™ GEN II

P/N: MTF-202

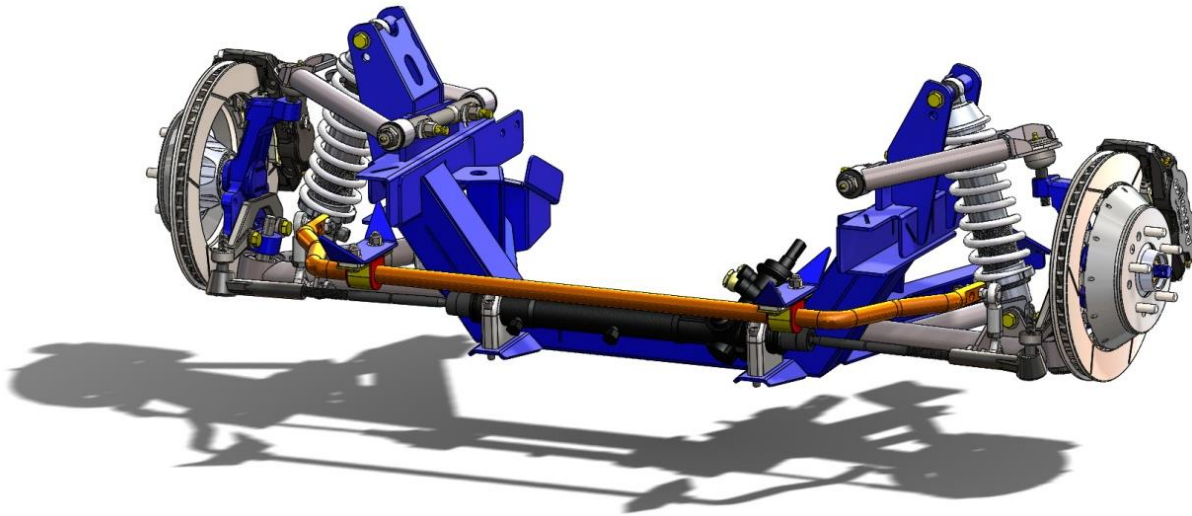

Please read these instructions *completely*
Before starting your installation.

Assemble suspension on vehicle before powder-coating to ensure proper fitment, and to make modifications if necessary.

For questions on installations please call 800-841-8188 In Illinois (847) 487-0150



PARTS LIST

- 1) K-member Sub-frame (Note: Motor Stands already Welded On)
- 1) Drivers Side Shock Tower Saddle
- 1) Passenger side Shock Tower Saddle
- 2) Spindles
- 2) Upper Control Arms
- 2) Lower Control Arms
- 2) Springs
- 1) Wilwood Brake Kit
- 1) Power Rack & Pinion
- 2) Front Shocks

HARDWARE PACKAGE

- 8) ½-20 Nylock Nut
- 8) 5/8 SAE Washer
- 2) 5/8-11 x 5" Grade 5 Hex Bolt Grade
- 20) ½" SAE Flat Washer
- 2) ½-20 x 5" Grade 8 Hex Bolt
- 2) 9/16- 18 X 3.3 Bolts
- 20 9/16 Washers
- 4) 5/8-11 Nylock Nut
- 2) 5/8-11 x 4 ½" Hex Bolt
- 4) ½-20 x 2" Grade 8 Hex Bolt
- 6) ½-20 x 2 ¾" Grade 8 Hex Bolt
- 4) Shock Spacers MTF-216
- 2) 9/16-18 Lock nuts

OIL PAN RECOMMENDATION

- 289-302 - Canton 15-640
- 351W- Canton 15-690
- FE engines- Canton 15-874
- Big block- Canton 15-770
- 4.6L mod- Canton 15-780
- Coyote- Canton 15-736

For questions on installations please call 800-841-8188 In Illinois (847) 487-0150



You are about to install your HEIDTS™ suspension system. Please completely read the instructions before starting. Follow the instructions step by step, reading each step completely, and in a very short time your car will be sitting on the nicest riding I.F.S. kit available.

1) Begin your installation by jacking up your vehicle and supporting it on sturdy jack stands. The stands must be placed on the flat section of the frame rails close to the front body mounts. First remove the engine and transmission. **SAVE AND LABEL ALL FASTENERS FOR RE-INSTALLATION!** Remove the front wheels and shocks. Disconnect the brake lines and tie-rods. Next, remove the old steering box, pitman arm and lower control arms. After this, unbolt the factory crossmember from the frame. Cut the factory lower control arm mounts out. **See Figure 1.**

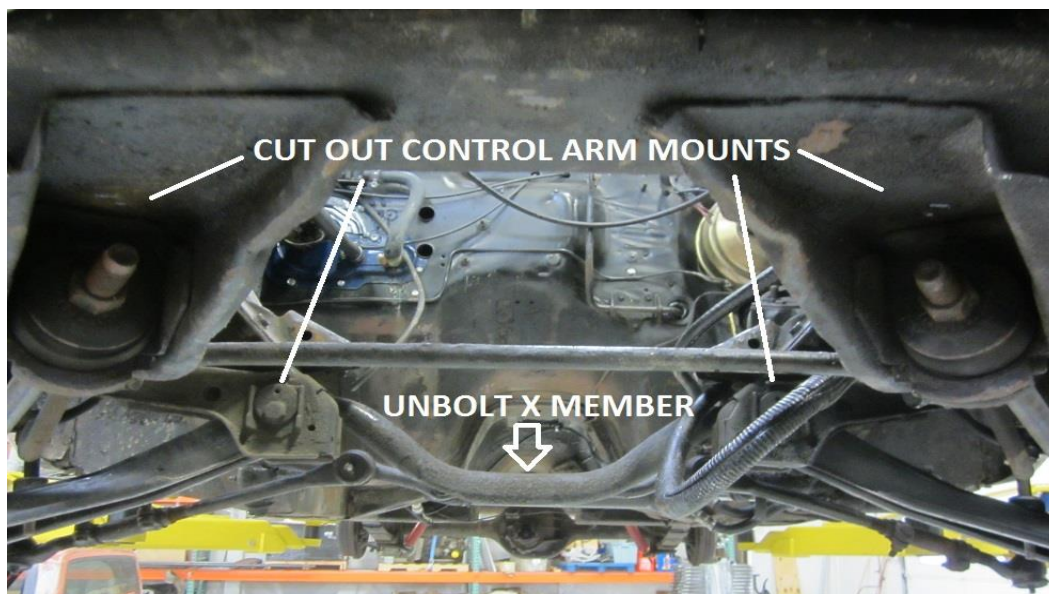

Figure 1

2) After the crossmember, lower control arms and mounts are removed, cut out the factory shock towers. Use the edge between the shock tower and the inner apron to get a clean cut of the shock tower. We provide inner fender panels to go in place of the cut out shock tower. **See Figures 2 and 3.**

For questions on installations please call 800-841-8188 In Illinois (847) 487-0150





Passenger side (Figure 2)

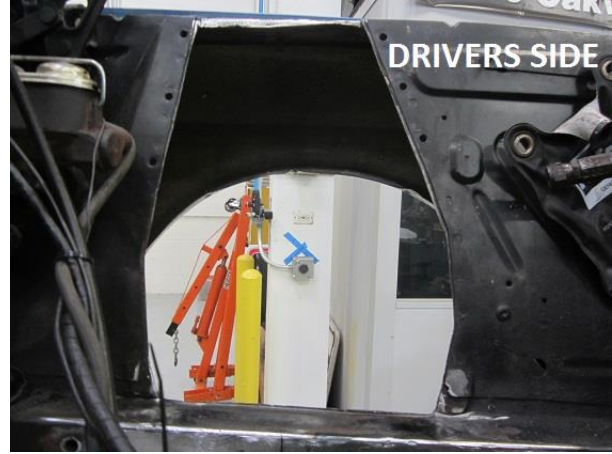

Drivers Side, shock towers removed (Figure 3)

3) Grind away and clean the rest of the front frame rails. It is important to have the entire frame rails cleaned for good clean welds. Clean away top, bottom, inner and outer frame rails. **See Figure 4.**



Figure 4

Bottom View of Engine Bay

4) Measure from the very front of the frame 24 1/4" and Sharpie a vertical mark. This is spindle centerline, and is a very critical dimension of this installation. **See Figures 5 and 6.**

For questions on installations please call 800-841-8188 In Illinois (847) 487-0150





Figure 5

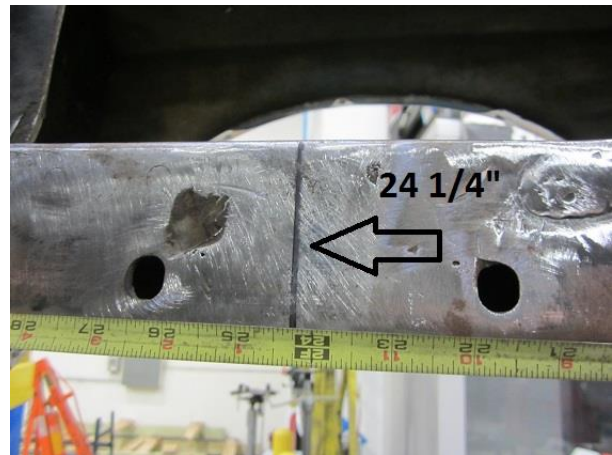

Drivers Side, Figure 6

5) Place the drivers side shock tower saddle onto the frame rail as shown in **Figure 7**. Note the orientation of the upper control arm mount holes, the front should be higher than the rear hole. Use the factory supplied 7/16" steering gear bolt to pre-locate the drivers side shock tower saddle. There are two 1/2" holes located on the shock tower saddle, the bolt should slide through both the first hole on the saddle and 1/2" factory frame rail hole shown in **Figure 7A**. Use the factory supplied 3/8" idler arm bolt to pre-locate the passenger side shock tower saddle, by placing through both the rear 1/2" hole in the saddle and the rear 1/2" hole in the frame rail shown in **Figure 7B**. You can discard the factory bolts after you are done aligning the saddles, they serve only as an pre-alignment guide.

Double check the location of the slot of the shock tower saddles and align the slot to spindle centerline. You should see the vertical Sharpie mark through the slot. Use adjustable clamps to securely snug the shock tower saddles to the frame rails. Tack weld the shock tower control arm saddles to the frame rails at this time. **See Figures 8**.

******Before fully welding Verify inner distance between arm upright plates is 28.6" as seen in the picture below. If measurement is narrower 0 degree camber may not be achievable******

For questions on installations please call 800-841-8188 In Illinois (847) 487-0150



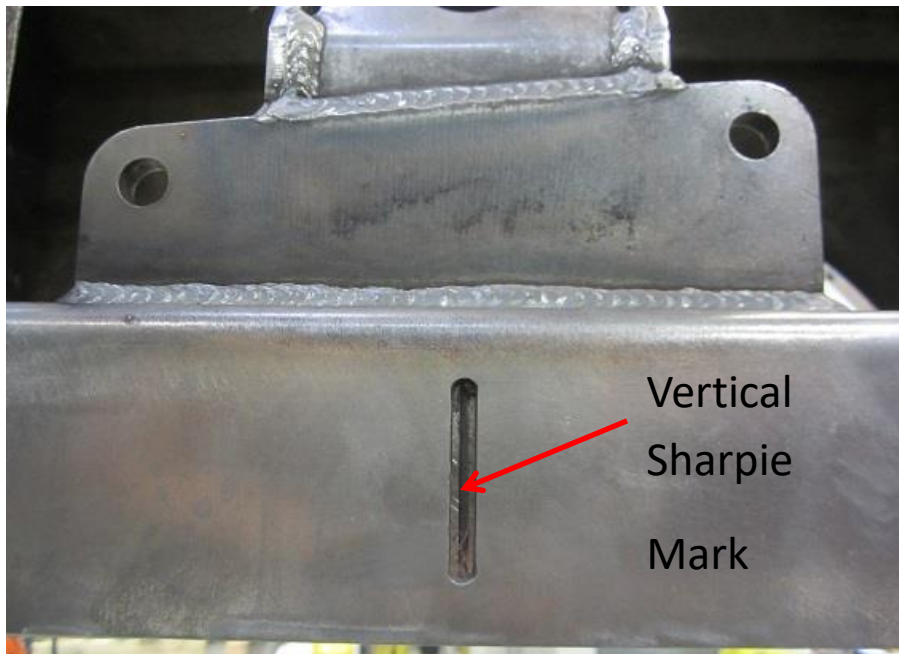
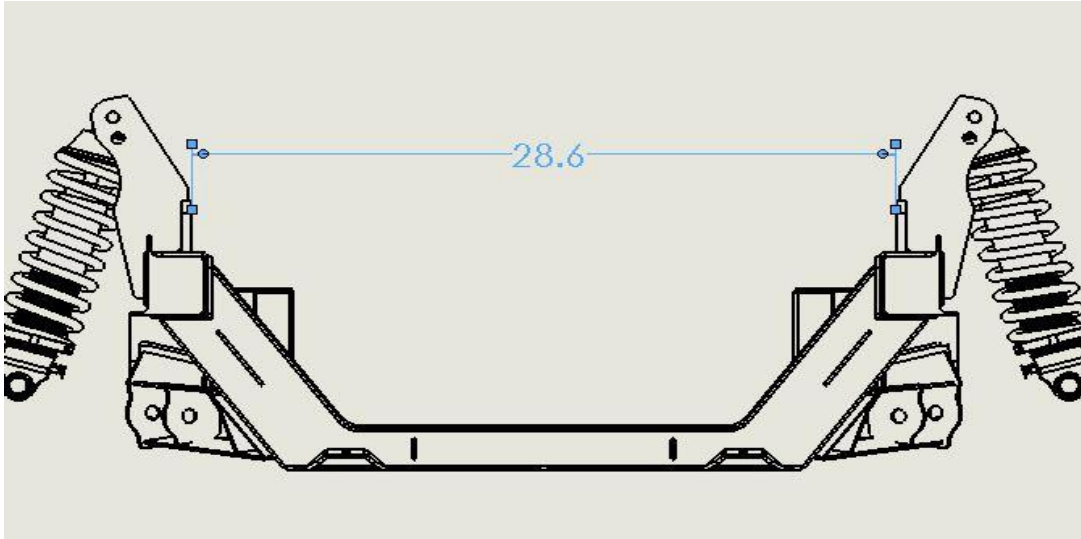

Saddle Alignment Window, Figure 7

For questions on installations please call 800-841-8188 In Illinois (847) 487-0150





Slide Factory 7/16" Steering Gear Bolt though Saddle and Factory Frame Rail, Figure 8



Use OEM 7/16" Dia. Steering Gear bolt, in Front Hole of Shock Tower Mount. Mounts in factory frame hole.

Drivers Side Alignment Bolt, Figure 7A

For questions on installations please call 800-841-8188 In Illinois (847) 487-0150



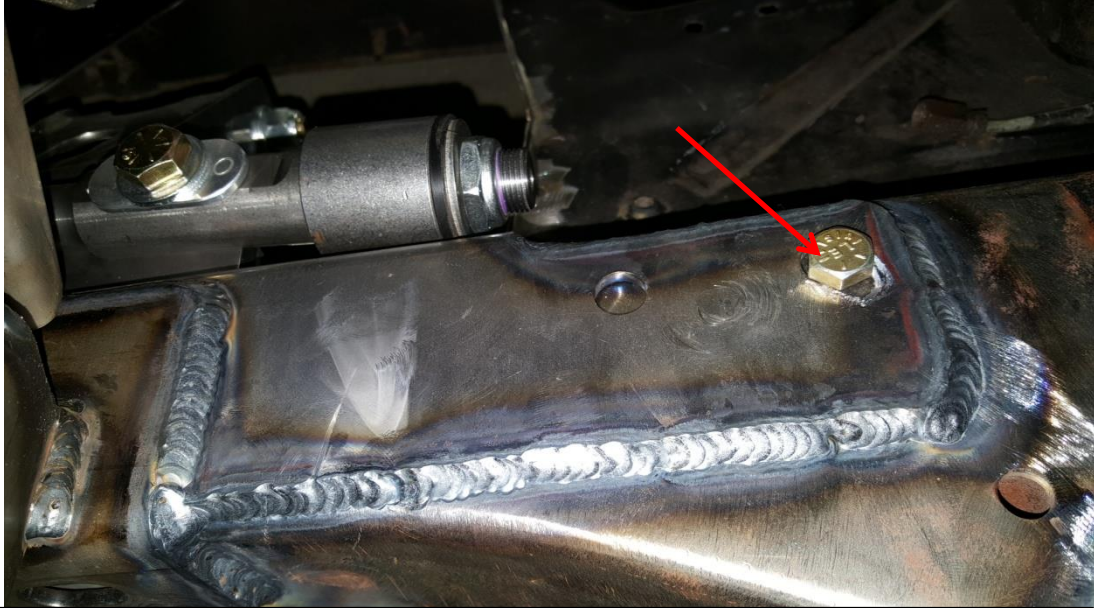

Use OEM 3/8" Dia. Idler Arm Bolt, in Rear Hole of Shock Tower Mount to locate. Mounts in Factory Frame Hole.

Passenger Side Alignment Bolt, Figure 7B

6) Place the front K-member into the vehicle locating the vertical slots on the K-member to the vertical slots of the saddles. Use adjustable clamps to secure the K-member to the frame rail saddles and the rear frame rails. **See Figures 9 and 10.**

For questions on installations please call 800-841-8188 In Illinois (847) 487-0150





Figure 9

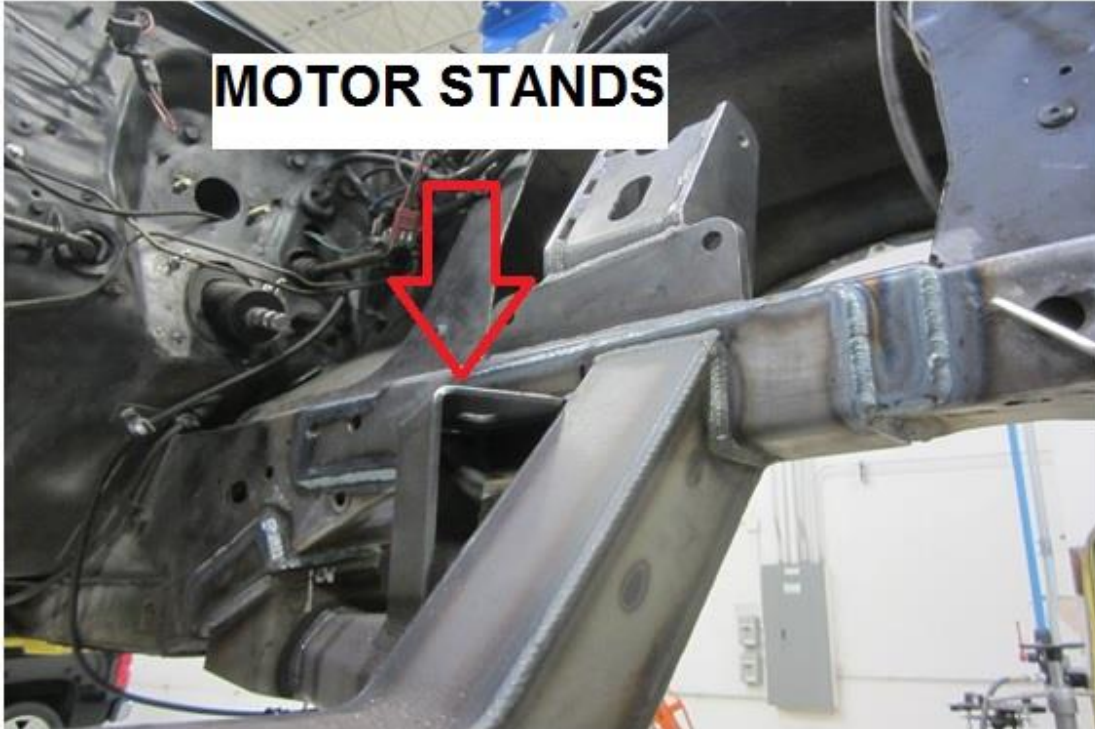

Figure 10

7) Once the K-member and frame saddles are in the correct location, fully weld all seams and slots to the frame of the vehicle. **See Figures-11-13.**

For questions on installations please call 800-841-8188 In Illinois (847) 487-0150





Drivers Side View from Engine Compartment, Figure 10



Driver Side View from Outside of Vehicle, Figure 11

For questions on installations please call 800-841-8188 In Illinois (847) 487-0150





Drivers Side View from Engine Compartment, Figures 13

8) Install the lower screw-in ball joint as shown in **Figure 14**. Use Anti-Seize on the threads of the ball joint before installation. Tighten ball joint until the ball joint is tight to the housing. Place ball joint boot on the top side of the ball joint housing. **See Figures 14-16**.



Figure 14



Figure 15

For questions on installations please call 800-841-8188 In Illinois (847) 487-0150



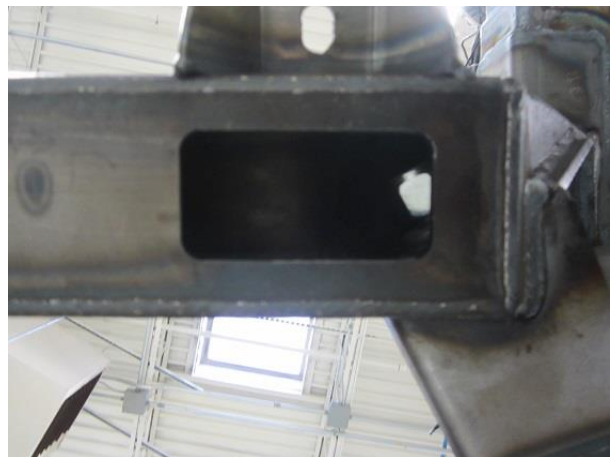

Figure 16

9) Install the lower control arms as shown in **Figure 17**. Use the 5/8-11 x 4 ½" hex bolts, washers and Nylock nuts for the front mount and the 5/8-11 x 5" hex bolts, washers and Nylock nuts for the rear. The cut out on the bottom of the cross member is for the front bolt installation. **See Figures 17-19.**



Figure 17



Bottom Cross Member Cut Out Figure 18

For questions on installations please call 800-841-8188 In Illinois (847) 487-0150





Figure 19

10) Install the upper control arm ball joints as shown in **Figure 20**. After the ball joints are installed, install the upper control arms as shown in **Figure 21D**. Install the aluminum upper control arm slugs **Figure 21A** into the upper control arm slotted shaft for the desired caster. The base kit comes with (4) zero inch offset slugs, measurement is from the center of the bolt (0 being center). The zero (0") slugs will provide you with 4-5 degrees of caster. If more caster is desired you will need to purchase offset slugs and swap out the control arm slugs. Aftermarket upper control slugs are made in 1/16" increments. These control arm slugs are available at Lefthander Chassis, (815) 389-999. The slug kits come in the following increments: 0", 1/16" 1/8", 3/16", 1/4", 5/16", 3/8", 7/16", 1/2", four slugs per kit, **Figure 21B**. The advantage of this system is you can quickly make camber adjustments without losing your caster settings.

Camber is adjusted by adding the camber shim plate between the shock tower and the outside of the upper control arm shaft. Any alignment shop has these shims on hand, but if you want the ability to quickly change camber at the track you will want to purchase your own, see Moog K960 Caster camber Shim kit **Figure 21C**. Use the supplied 1/2-20 x 2-3/4" grade eight hex bolts to secure the upper control arm. **See Figures 21D**.

For questions on installations please call 800-841-8188 In Illinois (847) 487-0150





Upper Ball Joint Installed, Figure 20A



LHC-Upper Control Arm Slugs, Figure 21A

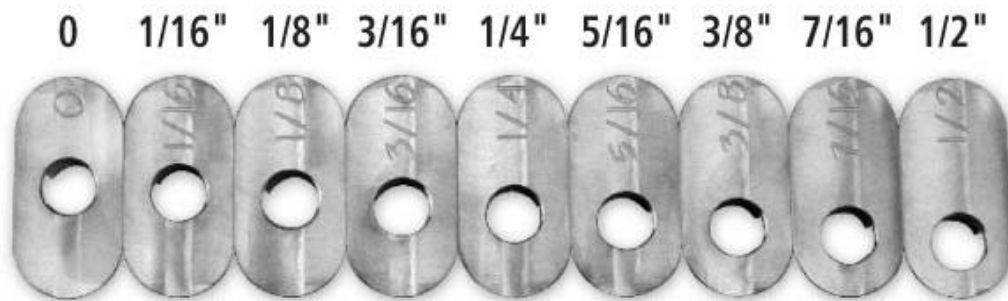

For questions on installations please call 800-841-8188 In Illinois (847) 487-0150

LHC-Upper Control Arm Slug Offset Options, Figure 21B

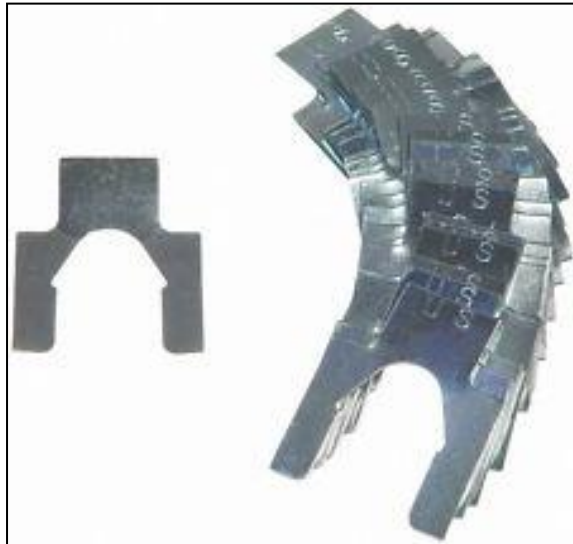

Moog K960 Camber Shims Plates, Figure 21C



Fully Assemble Upper Control Arm with 0" Control Arm Slugs, Figure 21D

For questions on installations please call 800-841-8188 In Illinois (847) 487-0150



11) Install the steering arms to the spindles as shown in **Figure 23**. Use Red thread locker on all 1.2-20 x 2" grade eight hex threads during installation. See **Figures 22 and 23**.



Figure 22



Figure 23

12) Install the spindles over the lower ball joints first. Thread the castle nut over the washer to secure the spindle to the lower ball joint. Attach the upper ball joint to the spindle as shown in **Figure 25**. See **Figures 24-26**.



Steering Arms Face Forward, Figure 24

For questions on installations please call 800-841-8188 In Illinois (847) 487-0150





Driver Side, Spindle attached to Ball Joints, Figure 25

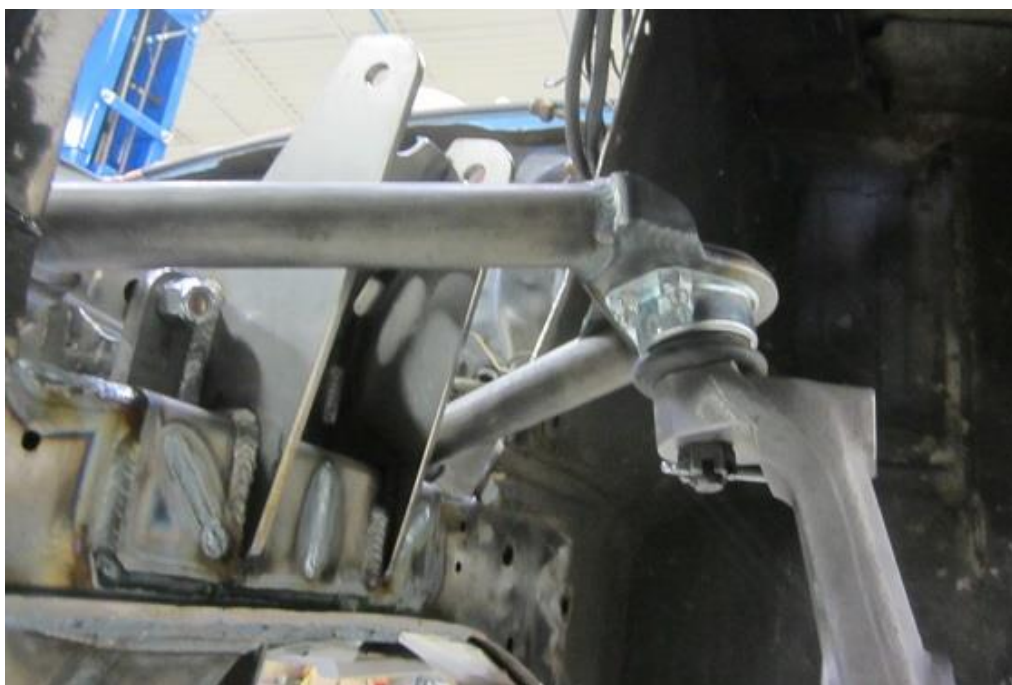

Upper Ball Joint Castle Nut installed, Figure 26

For questions on installations please call 800-841-8188 In Illinois (847) 487-0150



13) Install the coil over shocks. Use the ½-20 x 2 ¾" grade eight hex bolts, washers and Nylock nuts for the lower control arm mount. Make sure adjuster knob faces in-board for ease of adjustment. Use the ½-20 x 5" grade eight hex bolts, washers and Nylock nuts along with the aluminum spacers to secure the shock to the upper mount. **See Figures 27-30.**



Figure 27

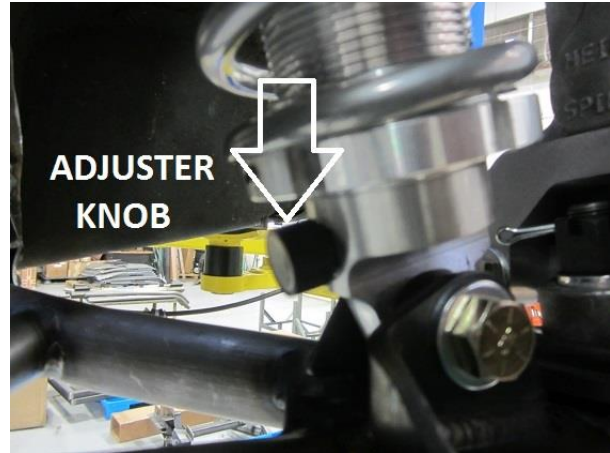

Figure 28



Figure 29



Figure 30

14) Mount the sway bar using the adjustable end links provided in the sway bar kit. Attach the sway bar to the end links and mount the end links snug to the lower control arm mounts. Make sure the end links are straight up and down front to rear and left to right. USE ANTI-SEIZE on threads of adjustable links. **See Figures 31 and 32.** May want to mount the female rod end on the top side so it doesn't trap any water in the threads, the opposite is pictured below.

For questions on installations please call 800-841-8188 In Illinois (847) 487-0150





Figure 31



Figure 32

15) After the end links are snug to the lower control arms, install the sway bar bushings as shown in Figure 33. Use 7/16-14 x 1 1/2" grade eight bolts, washers and Nylock nuts to assemble the sway bar bushings and 3/8" spacers to the sway bar mounting brackets. Clamp the sway bar bushings and mounting bracket assembly to the factory frame. Double check the end link bushings to make sure they are straight up and down as described in step 14. Once the mounting bracket is flush with the bottom of the frame, tack weld the mounting bracket to the frame. **See Figures 33-34.**

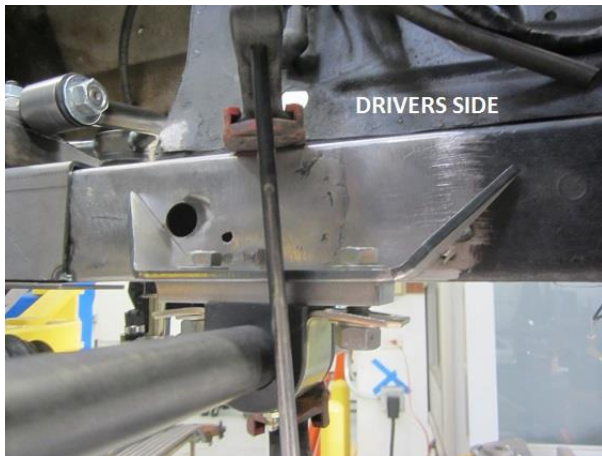

Figure 33



Figure 34

16) Install and tighten the sway bar collars as shown in **Figure 35**. Once the sway bar is at desired location, fully weld the sway bar mounting brackets to the frame. **See Figures 35 and 36.**

For questions on installations please call 800-841-8188 In Illinois (847) 487-0150



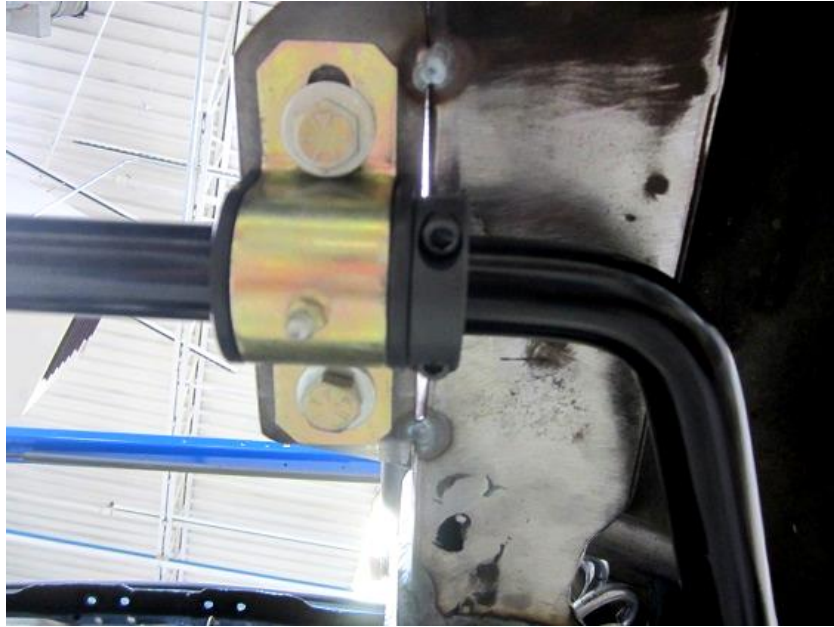

Figure 35



Figure 36

17) The figures below show the installation of the splined sway bar. Use grease on the bushings for ease of installation. Sway bar collars lock the splined bar on the inside of the sway bar mounting brackets. Install the torsion arm as shown in **Figure 37**. Make sure the adjustable link is straight up and down front to rear and right to left. See **Figures 37 and 38**.

For questions on installations please call 800-841-8188 In Illinois (847) 487-0150





Bushing & Clamping Collar from Inside of Sway Bar Mount, Passenger Side Shown, Figure 37



Splined Sway Bar, Passenger Side, Figure 38

18) Next install the rack. Make sure to read the instructions included with the rack to find center. Use the 9/16-18 x3.5 bolts, nuts and washers to mount the rack to the k-member. Install the outer jam nuts and tie rods. Attach the outer tie rod to the steering arm.

For questions on installations please call 800-841-8188 In Illinois (847) 487-0150



Lastly, you are ready to set the alignment of your vehicle. Be sure to do so with the arms and shocks set at ride height (the lower control arms should be level). The caster settings are done with the upper control arm mount slugs. Zero offset slugs should put you in our recommended caster window. Camber is adjusted by adding or subtracting camber shim plates, which are available at your local alignment shop. Both sides have equal caster settings, or the vehicle will tend to pull to one side.

Alignment Specifications:

Caster: 3° to 6° Positive

Camber: 0° to 2° Negative

Toe: 0 - 1/16" Toe-In

Since you are now to the point where you have a finished, running Mustang it is time to test drive it. After a few hundred miles, double check the ride height and the alignment. The springs may have settled which would change the ride height and the camber setting. It may be necessary to re-adjust the ride height before changing the alignment. After this initial setting period, the springs and bushings should have pretty much taken their final set, so you should be on your way to many miles of cruising in style.

For questions on installations please call 800-841-8188 In Illinois (847) 487-0150

