

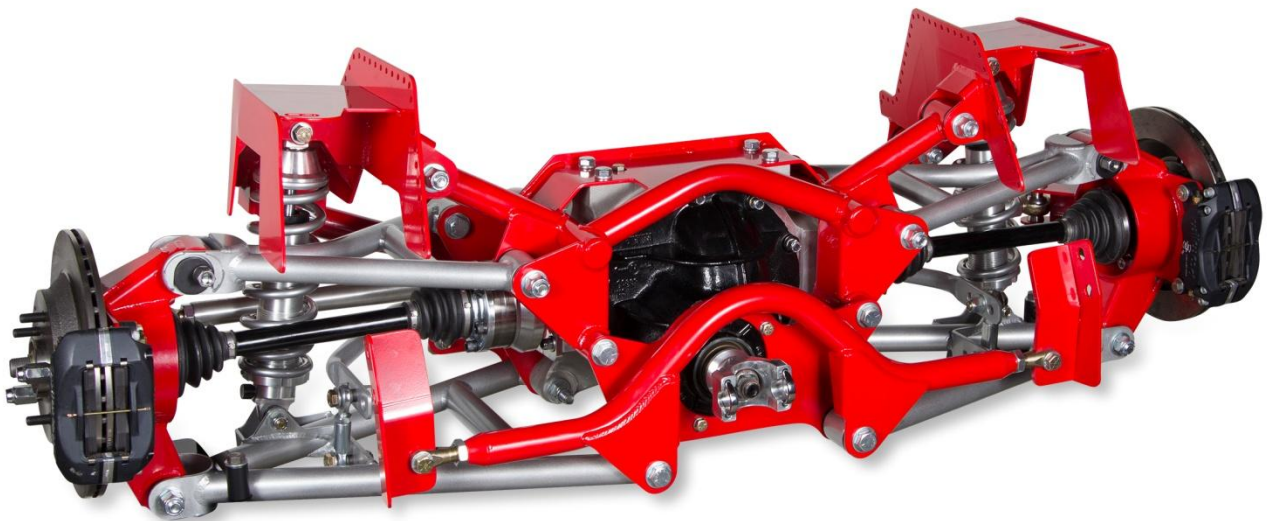

PRO-G IRS, 93-02 F-BODY INSTALLATION INSTRUCTIONS



Please read these instructions completely before starting your installation.

Remember the basic rule for a successful installation:

****** Measure Twice, Drill Once. ******

******Do Not Paint or Powder Coat any suspension components before trial fitting all items ******

For questions on installations please call 800-841-8188 In Illinois (847) 487-0150



Hardware Kit**Main Cradle Assembly**

| | |
|-------------------------|-----|
| 5/8"-11 x 4" Hex Bolt | (4) |
| 5/8" Washer, SAE | (8) |
| 5/8"-11 Nylock Nut | (4) |
| 1.38 Inch OD Bushings | (8) |
| 1/2"-13 x 1.5" Hex Bolt | (4) |
| 1/2" Washer, SAE | (8) |
| 1/2"-13 Nylock Nut | (2) |

Front Pinion Support Tube

| | |
|-------------------------|-----|
| 5/8"-11 x 1.5" Hex Bolt | (2) |
| 5/8" Split Washer | (2) |
| 3/4"-16 Clevis End, RH | (2) |
| 3/4"-16 Jam Nut, RH | (2) |

Front Pinion Support Brackets

| | |
|------------------------------|-----|
| M10 x 1.5 x 30mm Flange Bolt | (4) |
| 1/2"-20x1.25" Hex Bolt | (2) |
| 1/2"-20 Nylock Nut | (2) |

Upper & Lower Control Arm Hardware

| | |
|------------------------|------|
| 5/8"-11 x 4" Hex Bolt | (6) |
| 5/8"-11 x 6" Hex Bolt | (2) |
| 5/8"-11 Nylock Nut | (8) |
| 5/8" Washers | (16) |
| 5/16"-24 x 1" Hex Bolt | (4) |
| 5/16" AN Washers | (4) |

Steering Arm Hardware

| | |
|--|-----|
| 5/8"-11 x 4" Hex Bolt | (2) |
| 5/8"-11 x 3.25" Hex Bolt | (2) |
| 5/8" Washer | (8) |
| 5/8"x1/2" High Misalignment Rod End Bushings | (8) |
| 5/8"-11 Nylock Nuts | (4) |
| 3/4-16 Jam Nut, RH | (2) |
| 3/4-16 Jam Nut, LH | (2) |
| Rod End, 3/4" Spherical Bearing 3/4-16 RH Thread | (2) |
| Rod End, 3/4" Spherical Bearing 3/4-16 LH Thread | (2) |

Uprights, Left & Right

| | |
|---------------------------------|-----|
| 1/2" Cam Bolt Adjuster Assembly | (2) |
| 5/8"-11 x 4" Hex Bolt | (2) |
| 5/8" Washers | (2) |
| 5/8"-11 Nylock Nuts | (2) |

For questions on installations please call 800-841-8188 In Illinois (847) 487-0150



Hardware Kit (Continued)**Sway Bar, Rear**

| | |
|---|-----|
| 1/2"-20 RH Male Rod End W/ Stud | (2) |
| 1/2"-20 LH Female Rod End W/ Stud | (2) |
| 1/2" Jam Nut | (2) |
| 1/2"-20 x 2" Hex Bolt | (2) |
| 1/2"-20 Nylock Nut | (4) |
| 7/8" Diameter Anti-Roll Bar, Rear | (1) |
| Sway Bar Bushing Bracket & Bushings, Rear | (2) |
| 3/8"-16 x 1.25" Hex Bolt | (4) |
| 3/8" AN Washer | (8) |

Brake Bracket Adapter

| | |
|----------------------------------|------|
| 3/8"-16 x 1.25" Button Head Bolt | (6) |
| 3/8" AN Washers | (12) |
| 3/8"-16 Nylock Nuts | (6) |

C-4 Corvette Brake Option #1:

| | |
|---|-----|
| C-4 Brake Caliper w/ integral parking Brake | (2) |
| C-4 Brake Caliper Bracket | (2) |
| Brake Bracket Adapter, C-4 Caliper to Upright | (2) |

Wilwood Brake Caliper Option #2:

| | |
|---------------------------------------|-----|
| Wilwood Forged Dynalite Brake Kit | (2) |
| Brake Bracket Adapter, Single Caliper | (2) |

Wilwood Brake Caliper and Mechanical Parking Brake Option #3:

| | |
|---------------------------------------|-----|
| Wilwood Forged Dynalite Brake Kit | (2) |
| MC4 Mechanical Parking Brake Calipers | (2) |
| Brake Bracket Adapter, Dual Caliper | (2) |

Rotor Options:

| | |
|---|-----|
| C-4 Plain Rotors, Steel | (2) |
| Dimple Drilled & Slotted, Coated, Black | |
| Wilwood, Plain Rotors | |
| Wilwood, Drilled & Slotted Rotors | |

Low or High HP CV Shafts

| | |
|-------------------------------------|-----|
| Low HP CV-Shafts w/ 27 Spline Hubs | (2) |
| High HP CV-Shafts w/ 22 Spline Hubs | |

CV Shaft Hardware

| | |
|--------------------------------------|------|
| M10X1.5X 80MM Socket Head Cap Screws | (12) |
| M10 Split Lock Washers | (12) |

For questions on installations please call 800-841-8188 In Illinois (847) 487-0150



| | |
|---|-----|
| Coil Over Shocks | (2) |
| Single Adjustable Billet Coil-Over Shocks | |
| Rear springs, 10 inch | (2) |

Components

| | |
|-------------------------------|-----|
| Saddle Support, Left | (1) |
| Saddle Support, Right | (1) |
| Main Cradle Assembly | (1) |
| Front Pinion Support Tube | (1) |
| Lower Control Arm, Left | (1) |
| Upper Control Arm, Left | (1) |
| Upper Control Arm, Right | (1) |
| Pinion Support Bracket, Left | (1) |
| Pinion Support Bracket, Right | (1) |
| Upright, Left | (1) |
| Upright, Right | (1) |
| Pinion Support Plate | (1) |
| Rear Hubs | (2) |

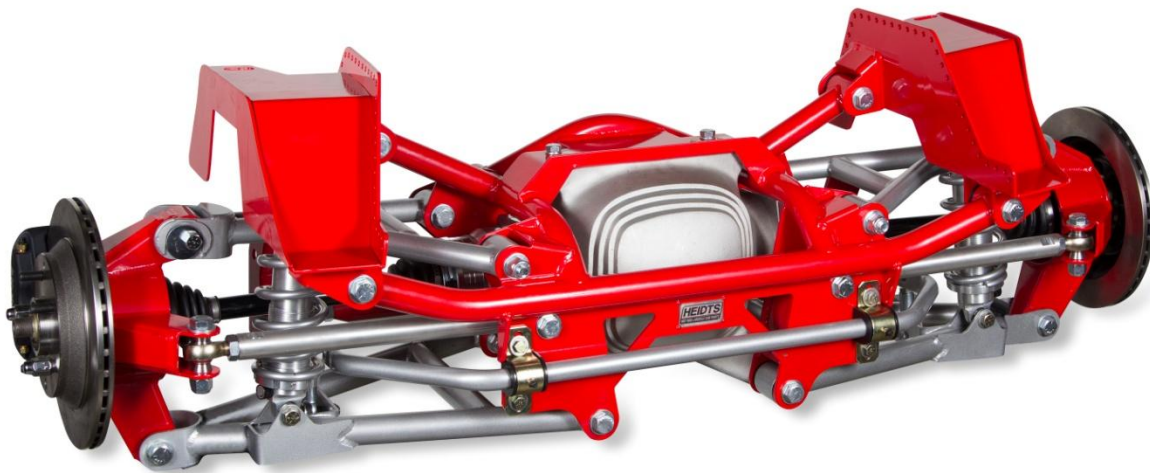

For questions on installations please call 800-841-8188 In Illinois (847) 487-0150



Directions:

Place the vehicle on a 4 or 2 post lift, make sure vehicle weight is on the lift locks. If using a 4 post lift you will need to place the car on jackstands, remove the rear wheels and verify the vehicle is level. If using a 2 post please make sure the vehicle is level. Next remove the stock rear axle, torque arm assembly, lower rear control arms, shocks and drive shaft. The underbody should look like the photo in Figure 1, after everything is removed. Then drain gas from tank, and disconnect and plug all fuel lines. Support the fuel tank and remove the two fuel tank straps. Carefully remove the tank from the car and store in a safe location away from flames, sparks or heat.



Figure 1

Prepare the frame rails by removing the inner sheet metal panels. A “Rotary Spot Weld Cutter” bit will come in handy, you can buy this from Harbor Freight look for, **Drill Master P/N 95343**, see **Figure 1**.

For questions on installations please call 800-841-8188 In Illinois (847) 487-0150





Rotary Spot Weld Bit, Figure 1

Mark all the spot welds shown in the photos by circling them with permanent marker on both the drivers and passenger side rear inner frame rails, as shown in **Figure 3 and 4 below**. You will start by cutting and removing the ends of the support that runs across the rear panel as where it is marked in **Figure 2**



Figure 2

For questions on installations please call 800-841-8188 In Illinois (847) 487-0150





Drivers Side Inner Frame Rails, Mark Spot Welds, Figure 3



Passenger Side Inner Frame Rails, Mark Spot Welds, Figure 4

For questions on installations please call 800-841-8188 In Illinois (847) 487-0150





Passenger Side, Inner Panel Shown, Fig. 5



Passenger Side, Inner Panel Removed, Fig. 6

Next circle the four spot welds on both sides of the panhard bar mount.

For questions on installations please call 800-841-8188 In Illinois (847) 487-0150





Panhard Bar Mount, Back Side, Figure 7



Panhard Bar Bracket, Front Side, Figure 8

For questions on installations please call 800-841-8188 In Illinois (847) 487-0150



Scribe lines inside Panhard Bar mount to mark cut off location, **Figure 9**.

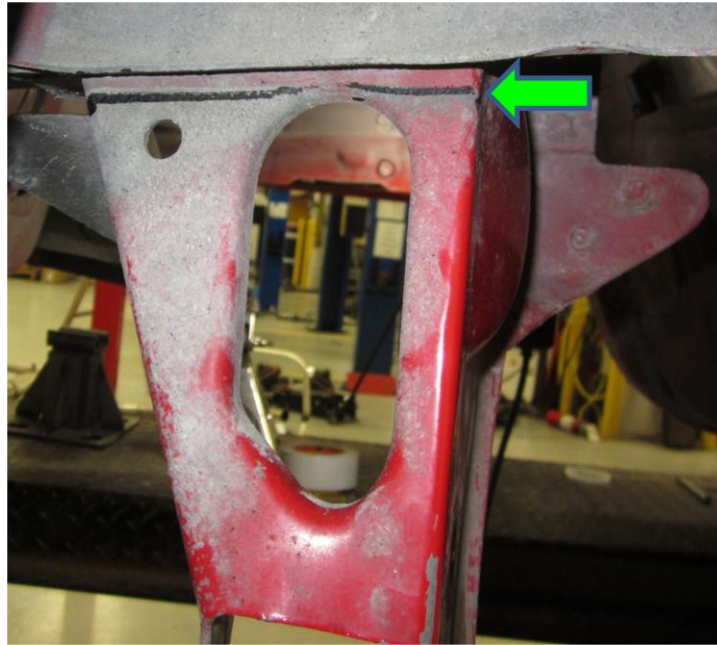

Mark cut off locations, Figure 9

Double check the area with the photos below before you start trimming process. Then, use a die grinder to cut off and remove the pan hard bar mount, this is no longer needed, **Figure 10**.

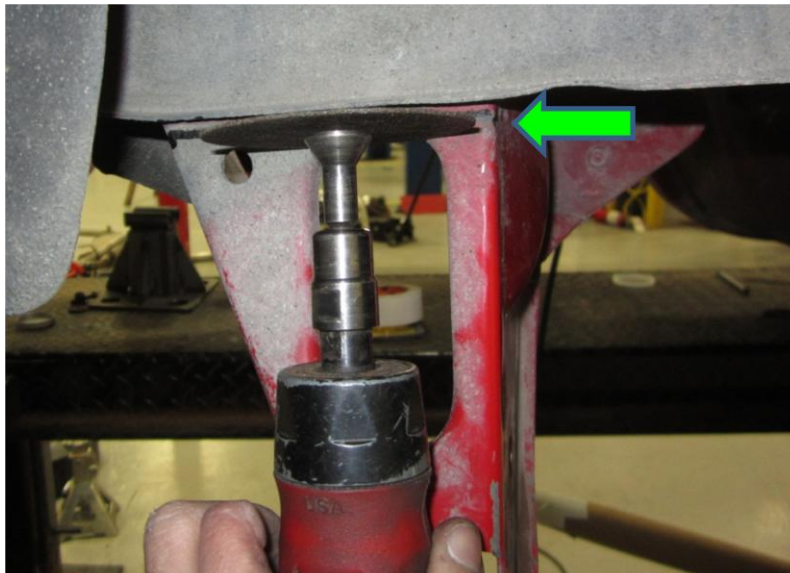

Cut Off Tool, Location, Figure 10

For questions on installations please call 800-841-8188 In Illinois (847) 487-0150



Remove the inner sheet metal support ribbing. When you are finished the drivers side should look like **figure 11** below. Note don't remove the outer frame rail sheet metal ribbing.



Drivers Side, Inner Panel Ribbing Removed, Figure 11

Next weld up all the spot weld holes and grind them down flush with the frame rails. Do this for both the drivers and passenger side frame rails. See **figures 12-15**.



Drivers Side Frame Rail, Spot Weld Holes Filled Figure 12

For questions on installations please call 800-841-8188 In Illinois (847) 487-0150





Passenger Side Frame Rail, Spot Hole Welds Filled, Figure 13

Pictured below are the driver and passenger side spring perches, see **figure 14 and 15**.



Passenger Side, Spring Perch Figure 14

For questions on installations please call 800-841-8188 In Illinois (847) 487-0150





Drivers Side Spring Perch, Figure 15

Remove the rear carpet interior, so you have access to the rear shock tower holes as shown below, **figure 16**. Insert the 1/2"-13 x 1.5" long hex bolts and washers supplied in the kit into each hole.



OEM Rear Shock Mounting Holes, Figure 16

For questions on installations please call 800-841-8188 In Illinois (847) 487-0150



Install the saddles, use the ½"-13 nylock nut, and ½" washers to hold the saddles in place, but don't fully tighten down the bolts yet.

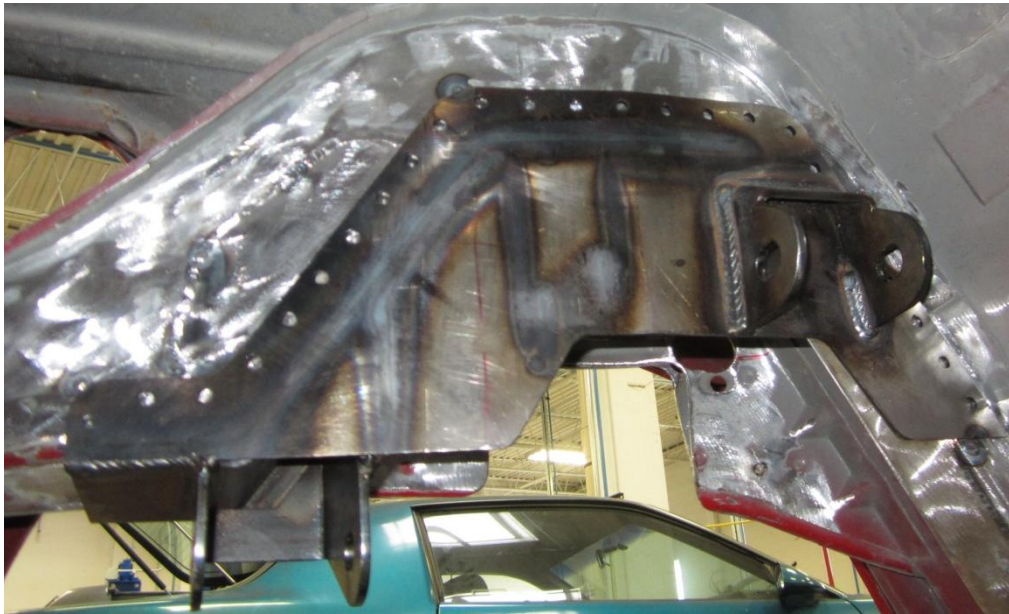

Install Drivers Side Saddle, Figure 17

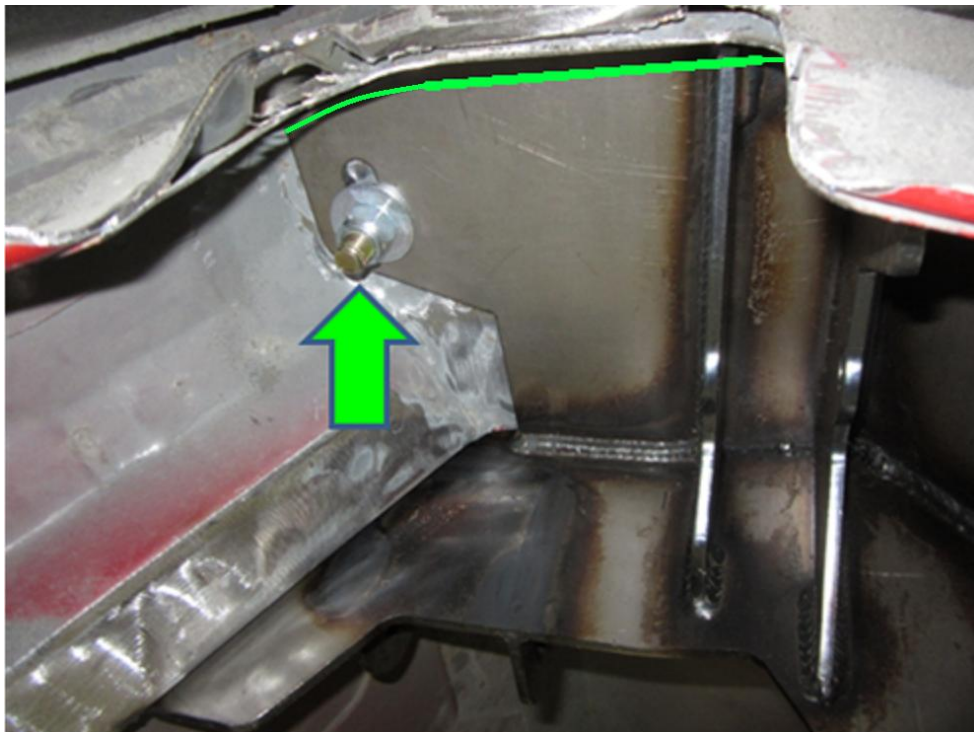

Trim Edge of Saddle at Green Line for Custom Fitment, Fig. 18

For questions on installations please call 800-841-8188 In Illinois (847) 487-0150





Install Passenger Side Saddle, Figure 19



Trim Saddle at Green Line for Custom Fitment, Fig. 20

For questions on installations please call 800-841-8188 In Illinois (847) 487-0150



Both the driver and passenger side saddle have an extra $\frac{1}{4}$ " of material that has been intentionally left on to account for tolerance between different frame rail widths. This extra $\frac{1}{4}$ " material needs to be ground away, so that saddle supports fit tightly against the inner frame rails and outer frame rail panel. The green colored line marks the edge that will need trimming, **see figures 18 and 20**. Keep trimming the saddles and checking the fitment until the inside panels fit flat against the inside of the frame rails as shown in **figure 17 and 19**.

Next find the main cradle assembly, install all 8 poly-bushings and 4 steel bushing sleeves. Use some grease on the outside diameters of the bushing to help ease installation. Then raise the main cradle assembly so that it fits into the rear mounts on the saddle supports. Install the 2 $\frac{5}{8}$ "-11 x 4" long bolts, washers and nylock nuts from the rear side, as show in the picture below. The two front cradle mounts have been left off the saddles due to variances in vehicles. You will need to install them onto the front mounts and weld them on. After it is up in the car start by making sure the cradle is level. A level and/or angle gauge is highly recommended. Set level/angle gauge reading from front to rear of vehicle. It is easiest to use the top diff mount plate since this flat plane is parallel with the pinion once the differential is installed. When you have leveled the cradle and supported it, insert the front mounts over the bushings. Some trimming may be required for exact fit. Use the 2 $\frac{5}{8}$ -11x4 bolts washers and nuts to hold them in place but do not over tighten. Once you have fit the mounts to your vehicle tack weld them to the saddles **do not fully weld them in at this time**

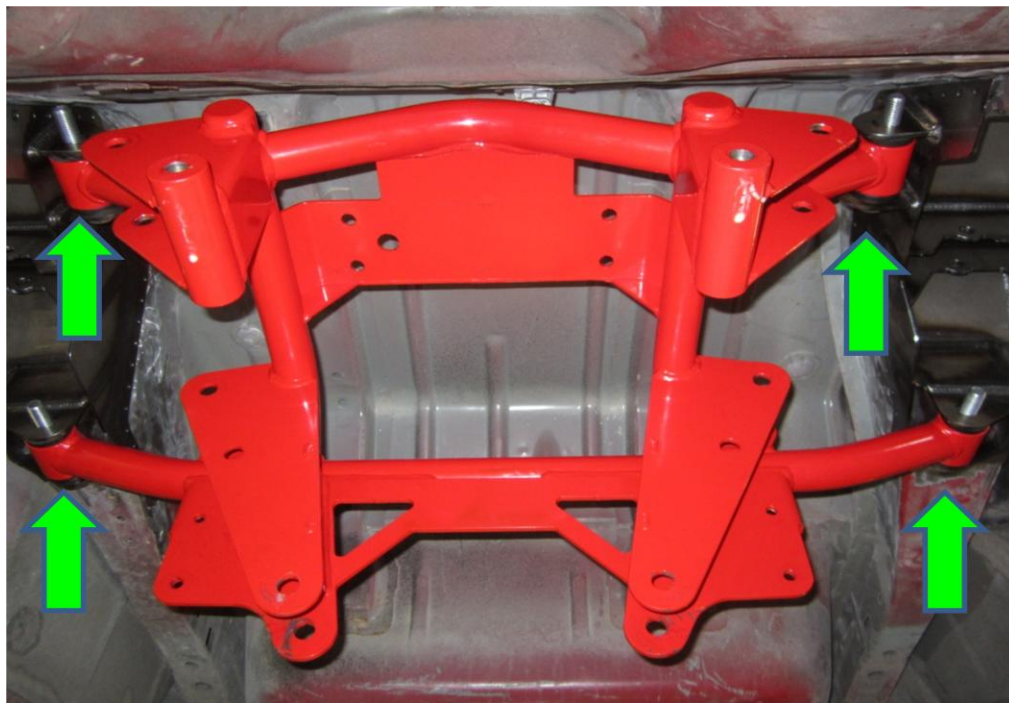

Main Cradle Assembly, Front View Figure 21

For questions on installations please call 800-841-8188 In Illinois (847) 487-0150



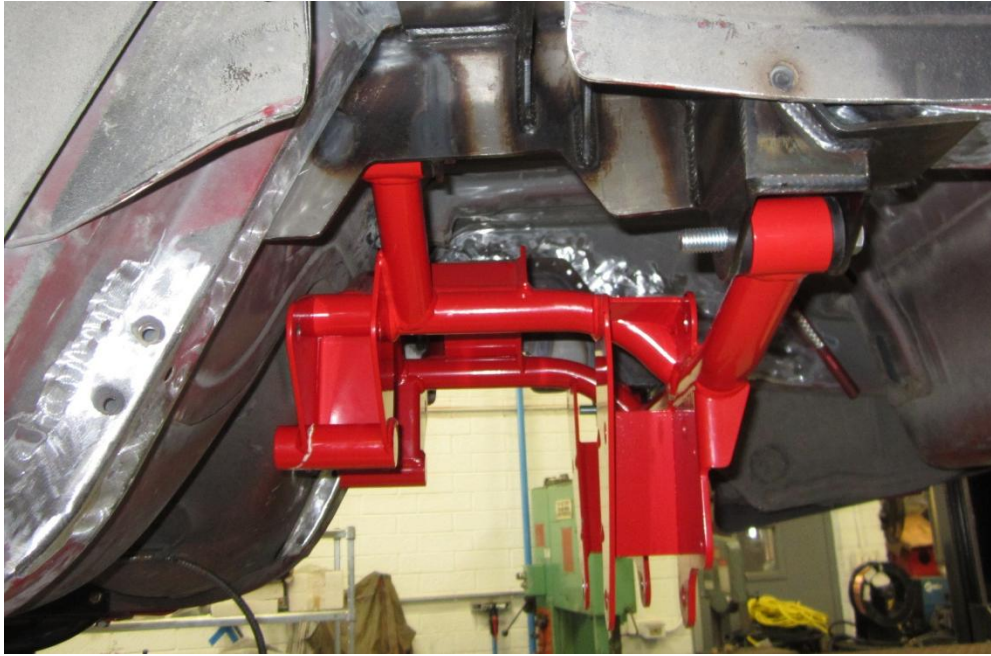

Main Cradle Assembly, Drivers Side View Figure 22



Main Cradle Assembly, Rear View Figure 23

At this point go back and tighten the two 1/2" x 1.5" bolts that are supporting the left and right saddles. Also tighten the four 5/8" x 4" long bolts that hold the cradle to the left and right saddles.

It's very important that the main cradle is correctly squared to the front end of the car! This is important because the upper and lower control arms aren't adjustable. This means you will not be able to easily re-adjust the wheelbase later, unless the welds on the saddle supports are removed and the saddle is physically moved to a new location. . The lateral needs to be checked as well, the IRS needs to be positioned on the vehicle center line of the car. The left and right saddle supports have slotted holes which

For questions on installations please call 800-841-8188 In Illinois (847) 487-0150



provide some adjustability to position the IRS assembly in center of the car. The IRS should be centered in both the lateral and longitudinal directions.

We recommend clamping a straight edge ruler to the rear cradle assembly and measuring each side front the original OEM control arm mounts to the straight edge rule and tapping with soft mallet until its square in the car. This means the measurements on each side will be the same! This is a very important step, measure this a few times to be sure, use the same tape measure on each side to be 100% sure your measurements are identical.

Next lay a couple small tack welds on each saddle side to lock it in place and hold the saddles up in place and keep them from moving. We recommend first to completely mock up all the moving suspension components i.e. the upper and lower control arms and uprights. Set the suspension at the correct ride height and camber and toe before you attempt to check your left and right wheel bases. Proceed with installing the upper control arms, lower control arms and uprights so that you can measure the wheel base and verify that you have the cradle square in the car before you attempt to fully weld the saddles and front cradle mounts. Measure the actual wheel base and compare it to the factory wheel base of 101 +/- .25 inches. If you find that one side is short or long, break the tack welds on the saddle supports and move that side correspondingly forward or back till the 101" wheel base distance is achieved on both sides. Be sure to re-tack the side again if you had to break it loose. After you are 100% satisfied with the wheel base proceed to the next step.

Now it's time to permanently tack weld up the saddles to the frame rails. Remove the uprights and upper and lower arms. With the main cradle assembly still in place weld as much of the saddles in as possible, this will help minimize any distortion effects while welding. At this point you will also weld the front cradle mounts. Weld as much of the 24 spot weld holes and around the perimeter of each saddle as you can. Weld the spot welds first then weld around the outside perimeter edge of each saddle to minimize distortion.

Remove the main cradle assembly and finish welding the spots you weren't able to reach with the cradle installed.

For questions on installations please call 800-841-8188 In Illinois (847) 487-0150



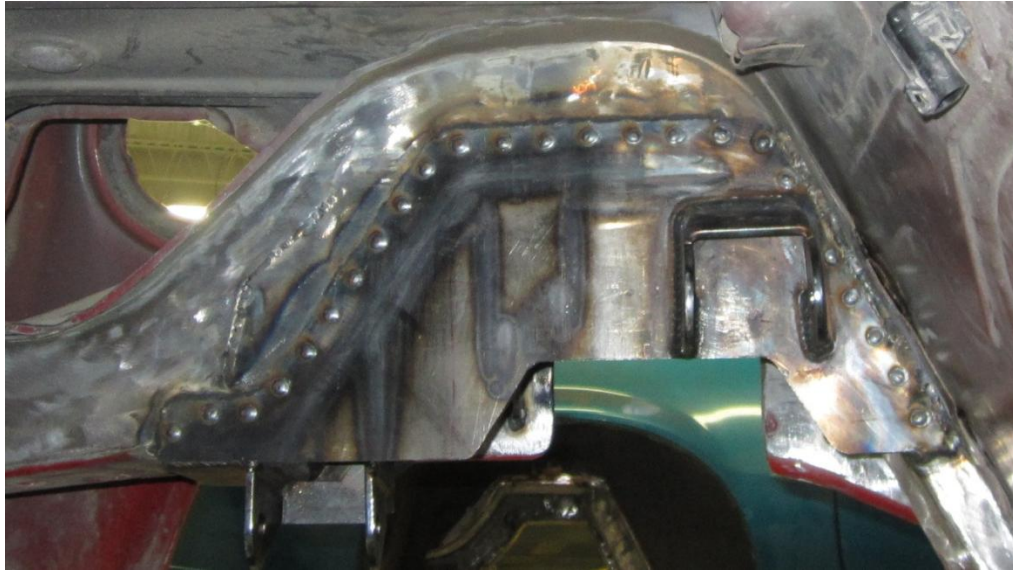

Welded Drivers Side Saddle, Figure 24

Remove the rivets for the fuel sending unit multi connector. This can be done by drilling out the two rivets. Push the multi connector through to the interior of the car. The connector will now be located inside the vehicle and placed under the driver side rear seat. Use the supplied block off plate to cover the hole

Reinstall the gas tank and the gas tank straps.

At this point the rear end housing can be assembled. Install the stub axle seals into the housing ends, one per side. Insert one seal into each side of the housing ends, with lips of the seal pointing inward, use a mallet to slowly tap the seals in until they bottom out on the shoulder of the bore. A seal installation tool will ensure that the seals are installed square and flush to the housing step. Do not tap on the seal directly, as the mallet could deform the seal, and cause an axle leak **See Figures 27-29.**



For questions on installations please call 800-841-8188 In Illinois (847) 487-0150

Center Section, Figure 27

Axle Seal Installed, Figure 28

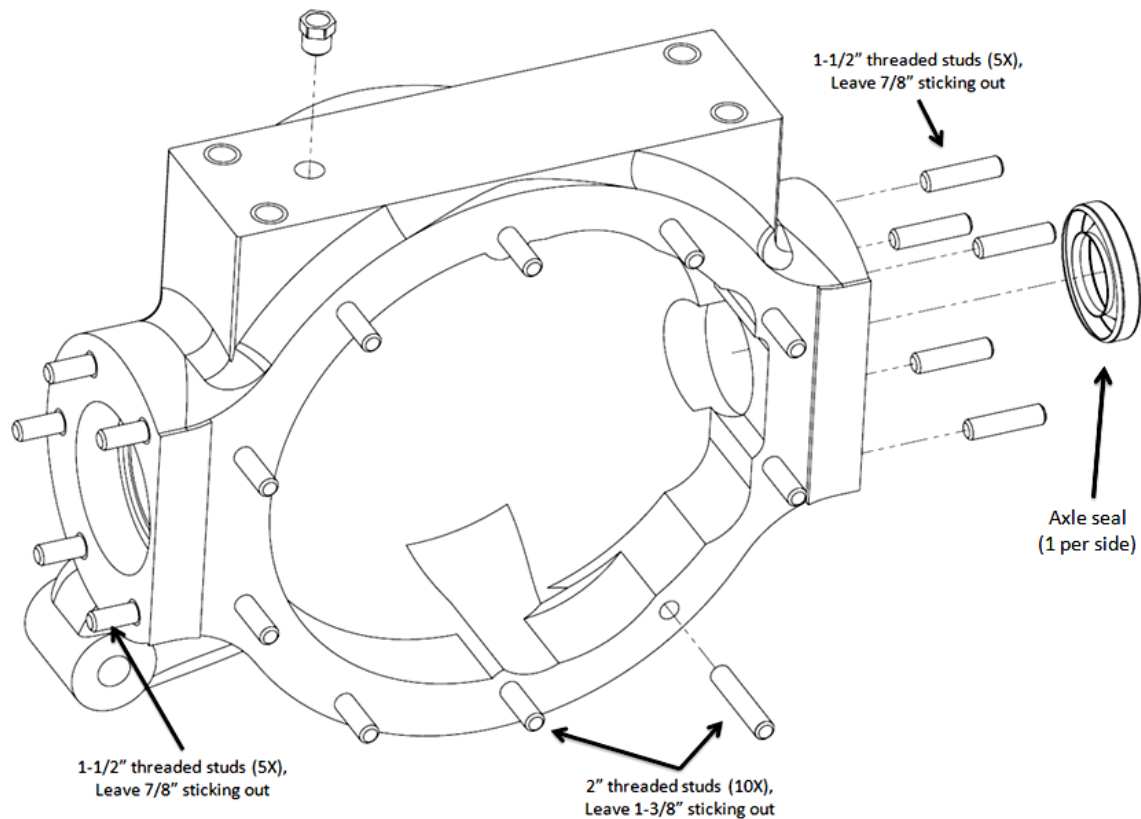

Center Section Diagram, Figure 29

The studs can be installed next. The 1 1/2" double threaded studs will be installed in the axle flanges and the 2" studs will be used for the 3rd member. Place the studs in a vice with a pair of soft jaws, to prevent damage to the threads when clamping. Using a wrench, thread on the 3/8" nylock nut until the nylock ring breaks past the threads. For the 2" studs the nylock nut is installed on the shorter threaded end of the stud. **See Figures 29, 30 and 31.**

For questions on installations please call 800-841-8188 In Illinois (847) 487-0150





Figure 30



Figure 31

Install the 3RD member using the 3/8" x 2" long threaded studs, nylock nuts and AN washers. Install using the Ford 9" third member gasket and or gasket sealer. Use thread locker on the studs. **Torque studs to 40 ft-lbs.**

The front pinion plate can be installed after the 3rd member is installed. Uninstall the five front bolts from the pinion retainer cover. Install the pinion mounting plate on the pinion carrier as shown in **Figure 32**. Use the 3/8-16 x 1 1/4" bolts and washers that were just removed. Use thread locker on the bolts. **Torque the 3/8 bolts 35-40 ft-lbs.**

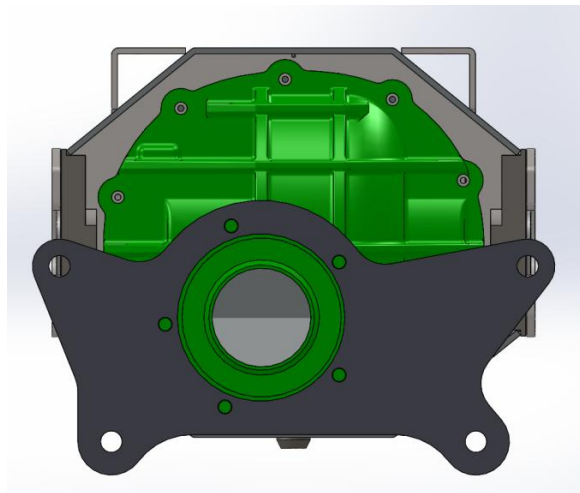

Front Pinion Plate, Fig. 32

For questions on installations please call 800-841-8188 In Illinois (847) 487-0150



Install the stub axle into the housing using white grease on the splines for ease of installation. The longer stub axle goes into the passenger side. Slide the stub axle into the housing until the bearing bottoms out in the housing bore, slide the retainer spacer next. Next install the bearing retainer plates using the 1 3/4" long threaded studs with the previously installed nylock nuts and washers. The machined sides of the bearing retainer plates face the center housing. **Torque the 3/8" studs to 50 ft-lbs. See Figures 33, 35a and 35b.**



Stub Axle, Bearing, Retainer Spacer, Fig. 33

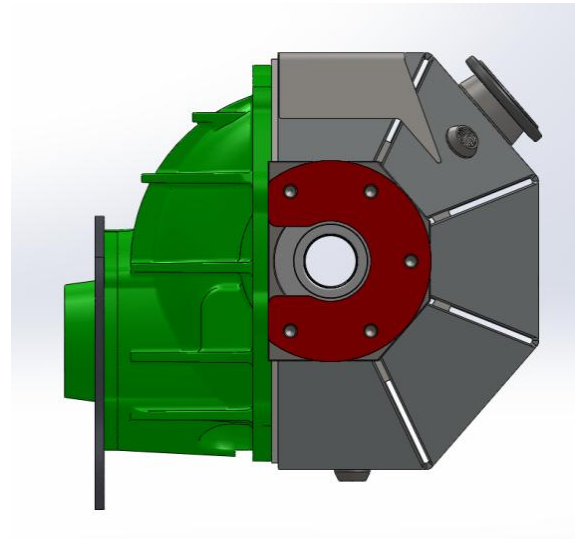

Bearing Retainer Plate, Fig. 34

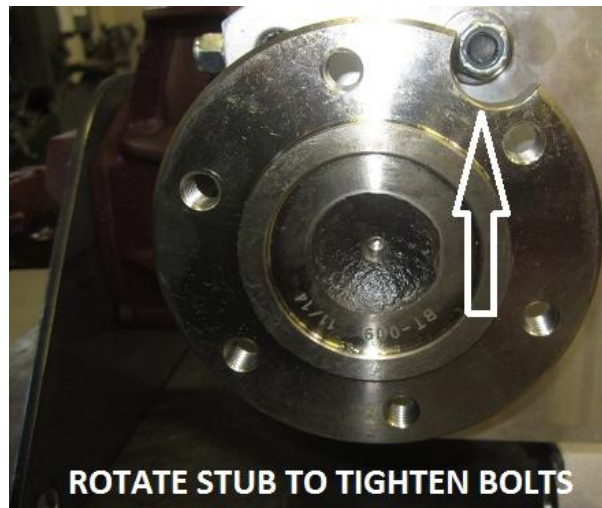

Rotate Stub Axle, to Tighten 5 3/8" Nuts Fig. 35

Install the drain plug on the bottom of the housing and the breather vent into the top. Use anti-seize on the plug and vent. **See Figures 36-39.**

For questions on installations please call 800-841-8188 In Illinois (847) 487-0150

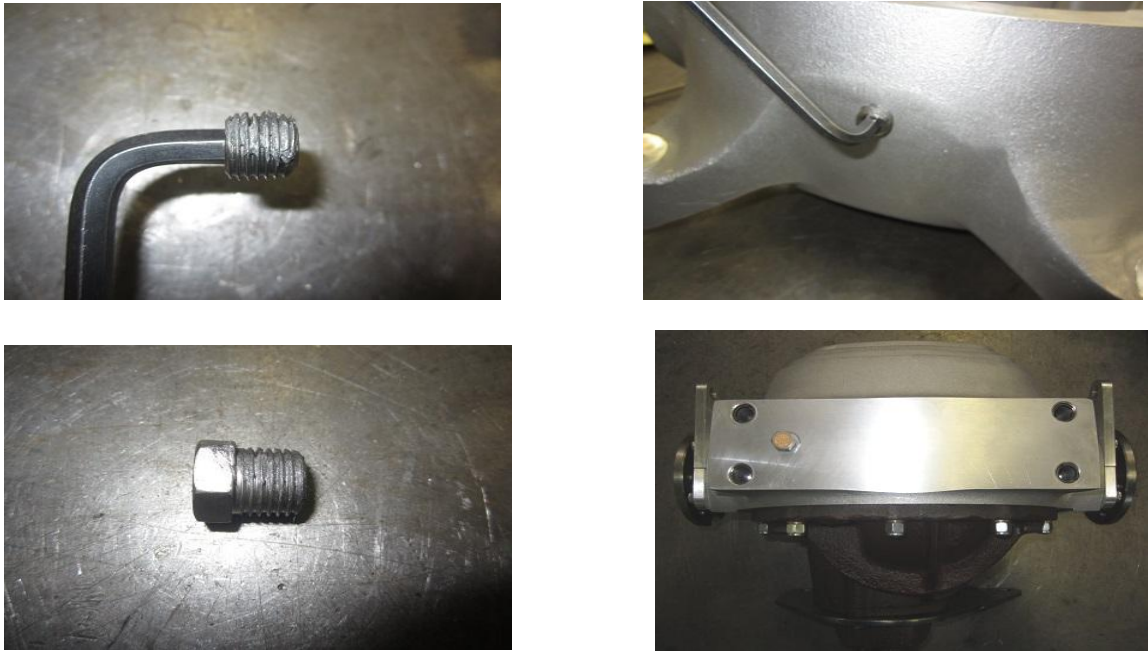

Figures 36-39

Install the cradle assembly onto the rear end housing using four $\frac{1}{2}$ -13 x 1" hex bolts and 1/2" washers. **Torque bolts to 70 ft-lbs, See Figure 40.**

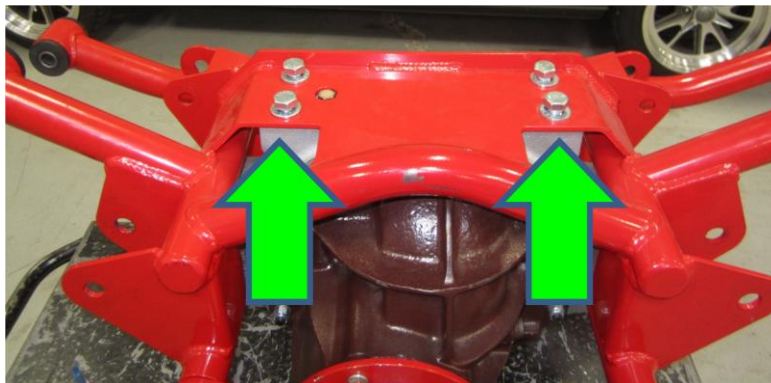

Main Cradle Bolted to Rear End Housing, Figure 40

For questions on installations please call 800-841-8188 In Illinois (847) 487-0150



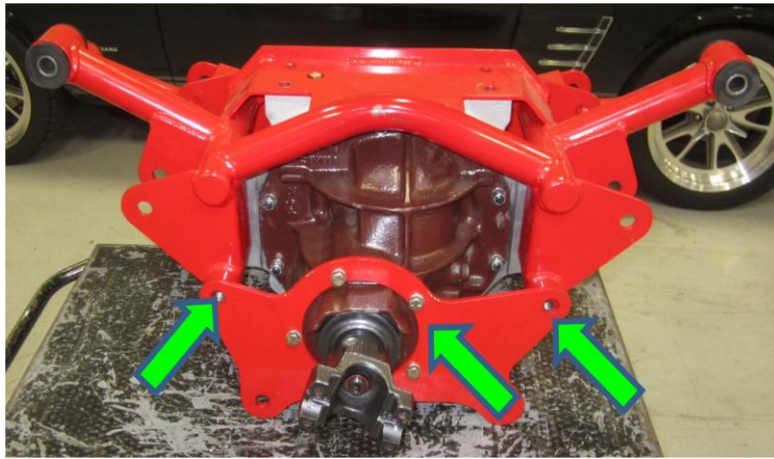

Front View, Figure 41



Rear View, Figure 42

Attach the front pinion mounting plate to the cradle assembly with the two 5/8"-16 x 1.5" bolts and 5/8" washers. **Torque 5/8" bolts to 75 ft-lbs, see Figure 41, 43, 44.**



Figure 43



Figure 44

For questions on installations please call 800-841-8188 In Illinois (847) 487-0150



Before you can reinstall the main cradle assembly you will need to drill a 1.5" hole on the drivers side rear bulk head . Use the holes in the mount on the saddle to get your hole center and drill through them towards the inside of the car. Once you have your center hole drilled you will use a 1.5" hole saw to cut your larger hole. The bolt will now be installed from inside the car

Slide the main cradle back into the saddle supports using the four 5/8-11 x 4" hex bolts, washers and nylock nuts. **Torque bolts to 75 ft-lbs as shown in figure 45, 46.**



Front Pinion Plate, Figure 45



Figure 46

Now it's time to install the front pinion support tube. Assemble the two 3/4"-16 RH clevis ends and 3/4-16 jam nuts in to the ends of the front pinion support tube as shown in **figure 47**. Thread in the clevis all the way in until they bottom out, then back out 5 full turns. This will serve as a good starting position for the clevis. You may need to adjust the clevis a turn in or out later on for better fitment later. Position the front pinion support assembly on the front side of the cradle and insert two 5/8"x 4" bolts through each of the 5/8" holes to hold up the pinion support tube. Next install the left and right lower control arms. You will start by removing one of the 5/8"x 4" on the side you are installing the control arm leaving the other side in to hold the pinion support. Install the lower control arm, then reinsert the 5/8"x 4 bolt though the front control arm bushing. Repeat on other side. Use the two 5/8"x 6" bolts, washers and nylock nuts to mount the rear of the control arm, refer to **Fig 49 cross section view** for the hardware assembly.

For questions on installations please call 800-841-8188 In Illinois (847) 487-0150



Make sure the lower control arms are mounted correctly, note the shock brackets will face upwards and also be located toward the rear, see **Figures 48**.

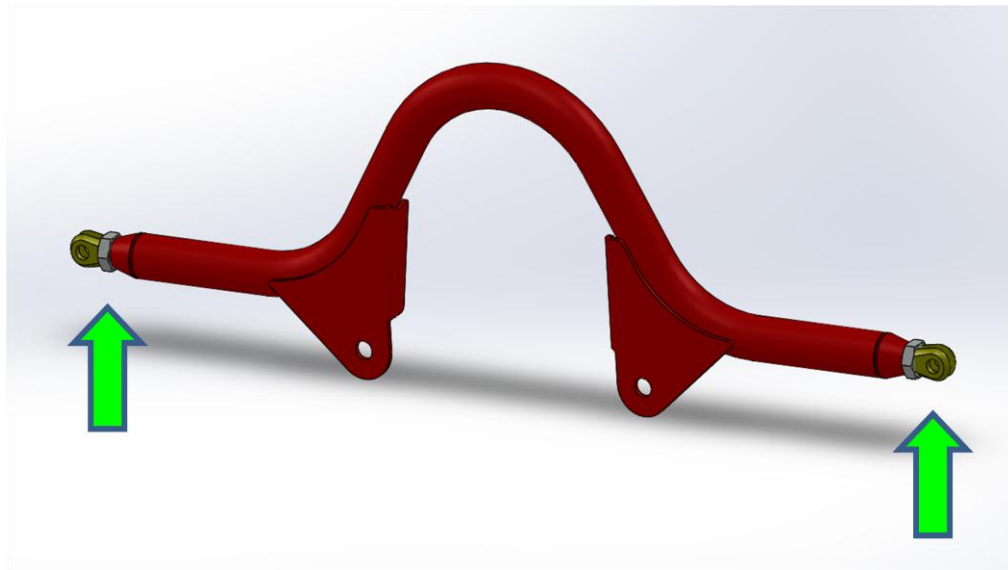

Front Pinion Support Tube w/ Clevis Ends, Figure 47

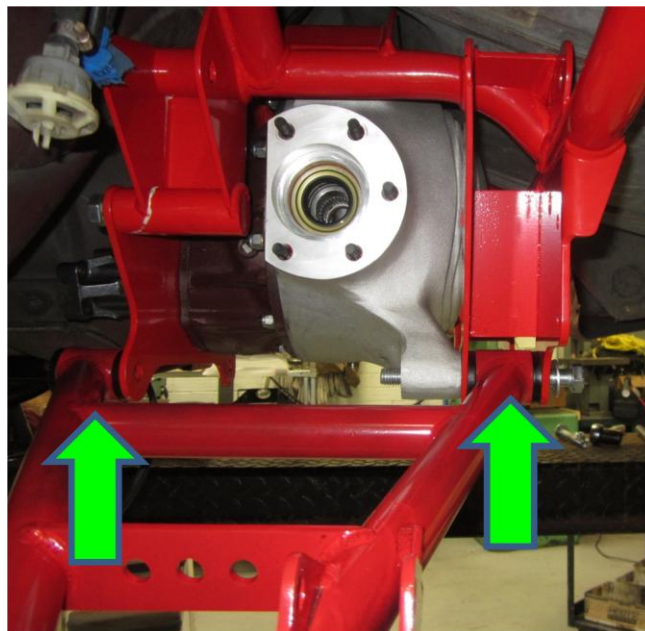

Lower Control Arm, Drivers Side, Figure 48

For questions on installations please call 800-841-8188 In Illinois (847) 487-0150



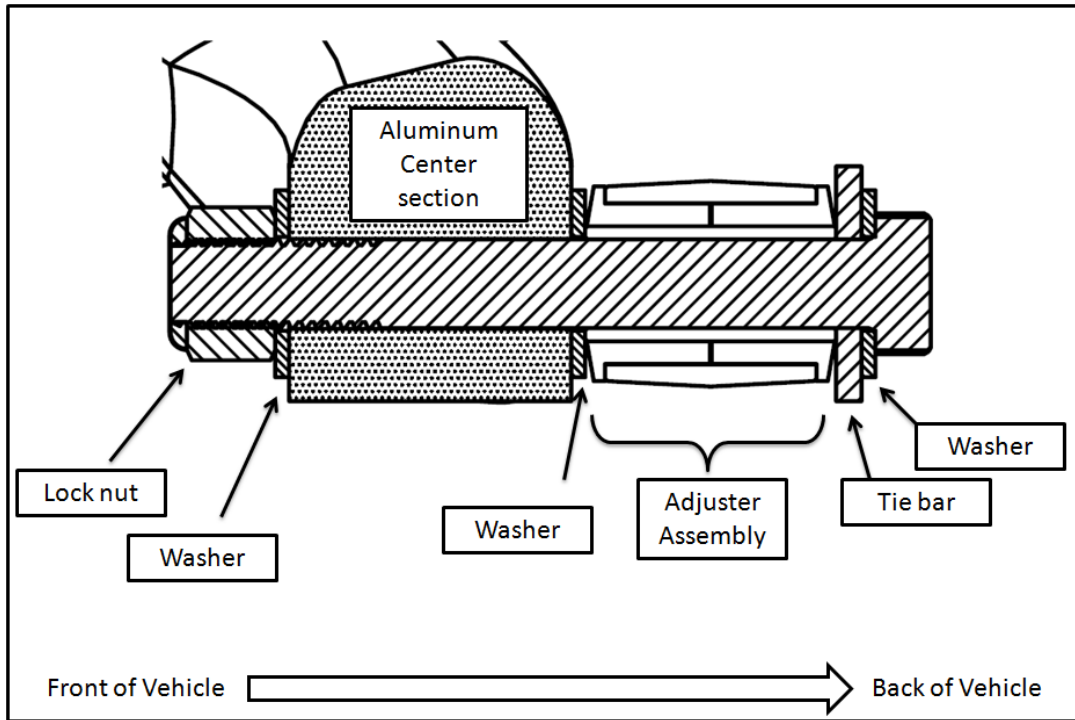

Rear Lower Control Arm Assembly, Cross Section View, Figure 49

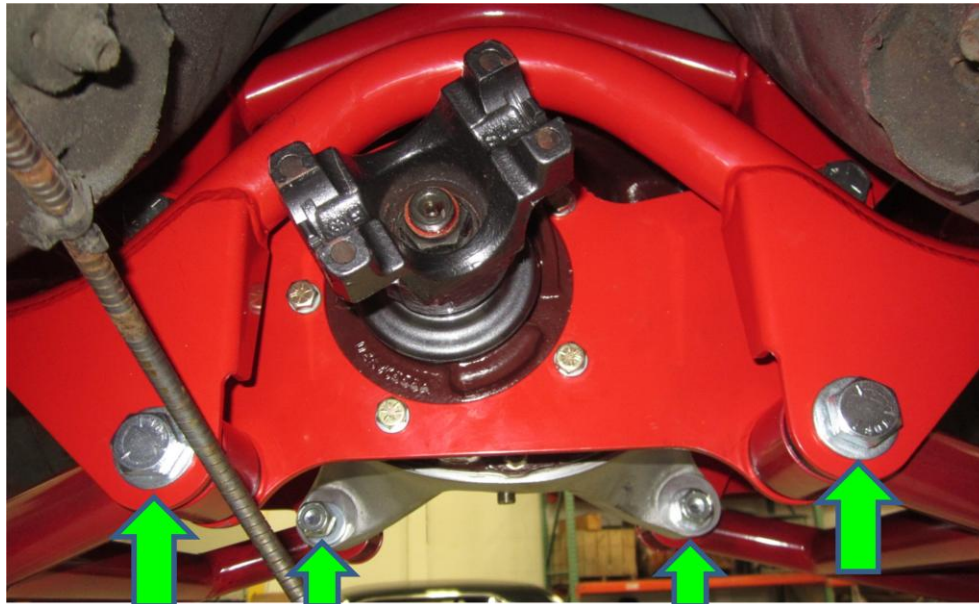

Front Pinion Support w/ Lower Control Arms, Figure 50

For questions on installations please call 800-841-8188 In Illinois (847) 487-0150



Install the upper control arms using the four 5/8" x 4" long bolts, washers and Nylock nuts, see **figure 51, 54**. The bowed sides of the upper control arms should face the rear of the car. **Torque to the 5/8" bolts to 75 ft-lbs.**

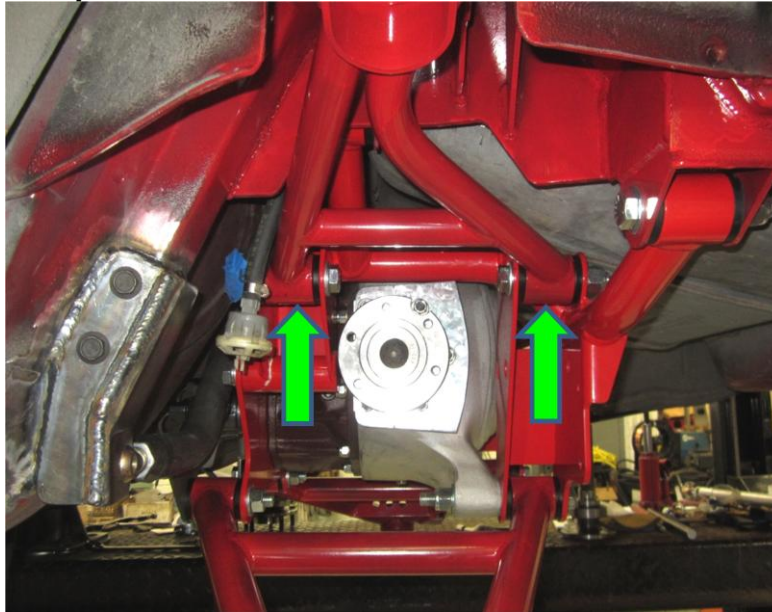

Upper Control Arms, Drivers Side Figure 51



Left Pinion Support Bracket, Figure 52

Next mount the left and right pinion support brackets **figures 52, 53, 54**. Adjust the clevis's if necessary, then mark the hole locations on the support brackets with a transfer punch. Drill through the left and right pinion support brackets with a 17/32" drill bit. Use the four M10 x 35mm long hex bolts to mount the left and right support brackets to the chassis. You may weld these one once you have finished installing.

For questions on installations please call 800-841-8188 In Illinois (847) 487-0150



Use the two ½ x 1-1/4” long bolts and nuts, to attach the clevis to though the saddle support brackets.

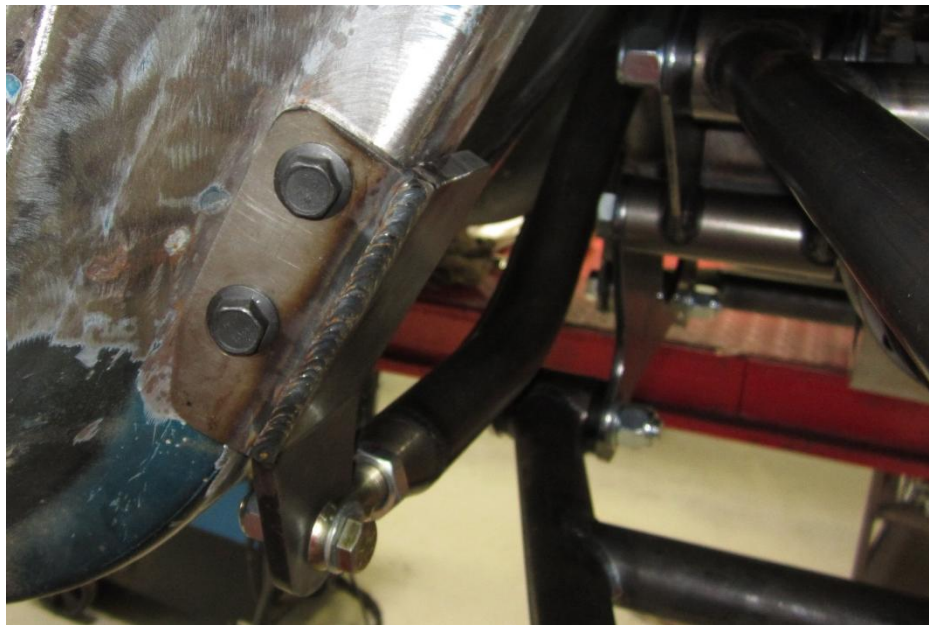

Left Pinion Support Bracket, Figure 53

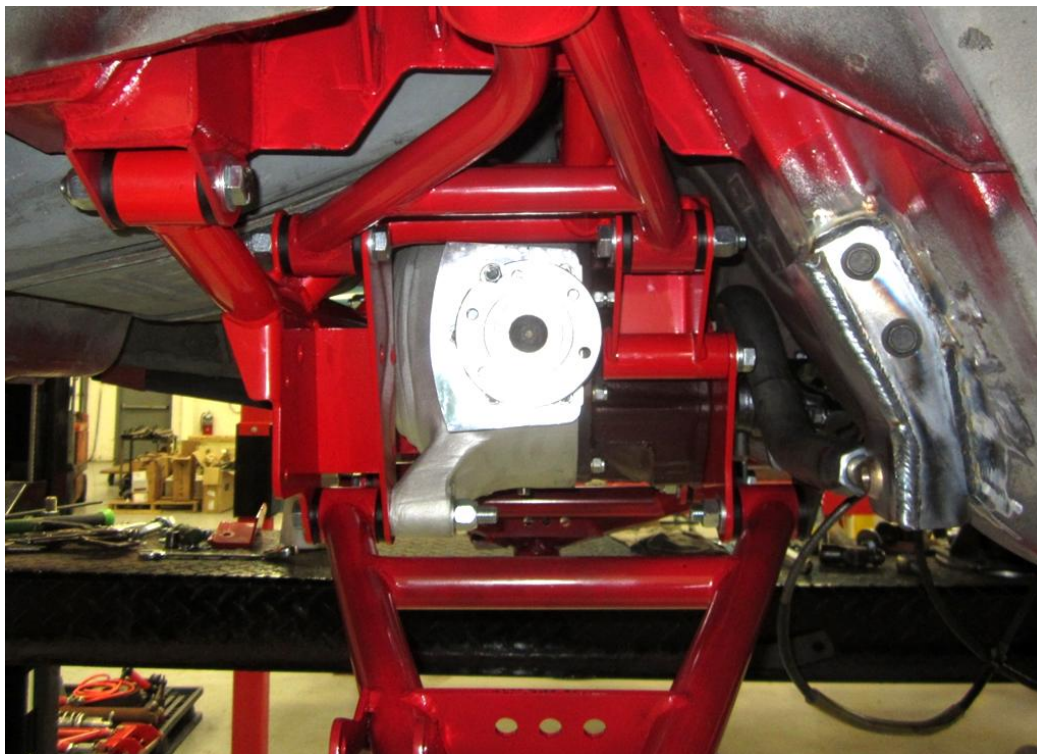

Right Pinion Support Bracket, Figure 54

For questions on installations please call 800-841-8188 In Illinois (847) 487-0150



Now that the upper control arm is installed, push the upper control arm until it hits the outer chassis rail panel, mark the area that touches. The panel will need to be trimmed to clear the upper control arm. The area that needs to be removed is 5.25" wide by 3.5" high square.

First find the center of the upper control arm, then trim the outer panel as needed to allow the upper control arm through it's 3" of compression travel range. Note other holes located to the left of the square cut out, are not needed. After you are finished, the left and right frame rails should look like **figures 55 and 56**.

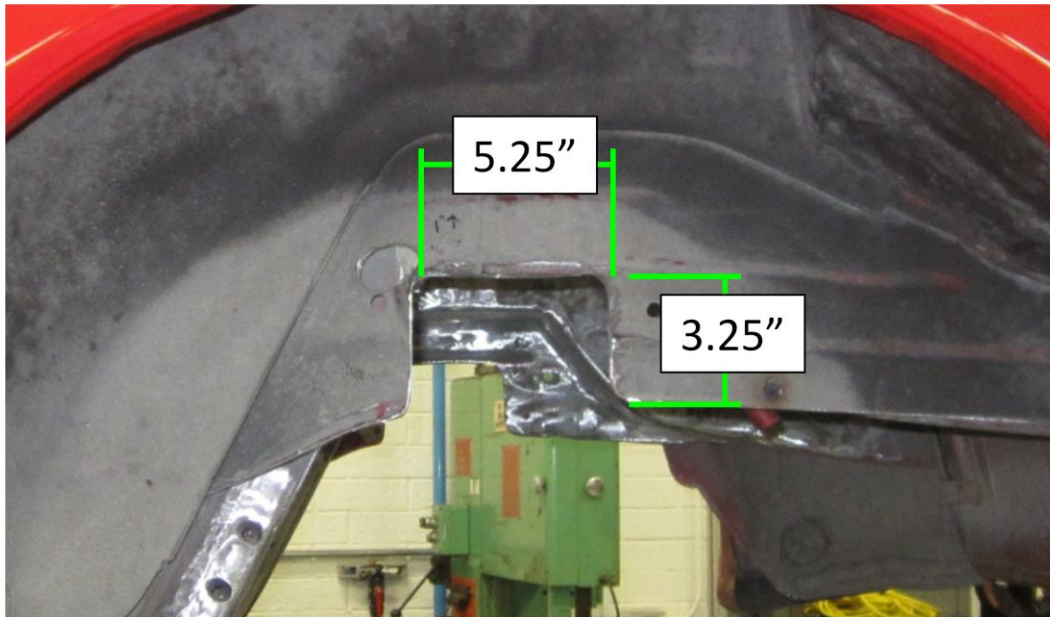

Drivers Side View, Upper Control Arm, Cut-Out, Figure 55



Passenger Side, Upper Control Arm, Cut-Out, Figure 56

For questions on installations please call 800-841-8188 In Illinois (847) 487-0150





Inside View, Drivers Side, Upper Control Arm Cut-Out, Figure 57



Inside View, Passenger Side Frame Rail, Figure 58

For questions on installations please call 800-841-8188 In Illinois (847) 487-0150



Next install the aluminum CV adapter spacer, to the end of the half shafts and use the twelve M10 x 80mm long bolts and split lock washer to fully install the CV joint axles to the axle stubs. Use thread locker on the bolt and **Torque to 51-57 ft-lbs. See Figures 52, 53, 54 and 55.** The bolts are long enough to run M10 Nord-lock washers, these are not supplied in the kit, but are a good option if you plan on racing or never want to worry about the bolts coming loose.



Apply Thread Locker, Figure 52



CV Adapter Flange, Figure 53

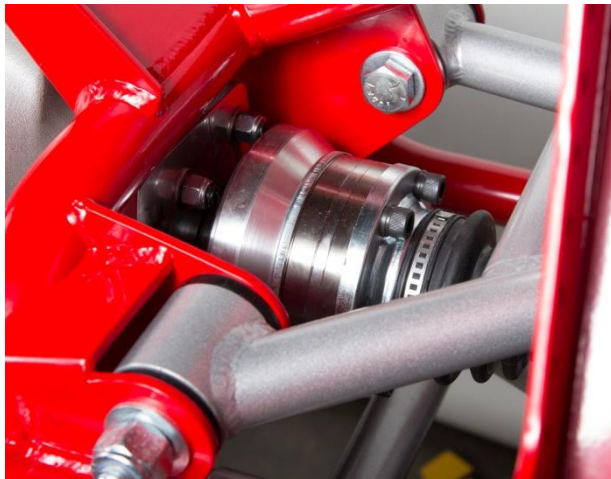

Figure 54



Figure 54

Install the outer bearing hub assemblies using the six M12 x 60mm long bolts and washers. If the hub assembly does not seat flush against upright, carefully open the hole on the upright using a barrel sander. Use thread locker on the M12 x 60mm bolts. **Torque bolts to 65 ft-lbs, see Figures 52-53.**

For questions on installations please call 800-841-8188 In Illinois (847) 487-0150





Figure 52



Figure 53

Next insert the eight polyurethane bushings in to the left and right uprights. Then insert the four bushing sleeves, use grease to help installation. **See Figure 54, 55.**

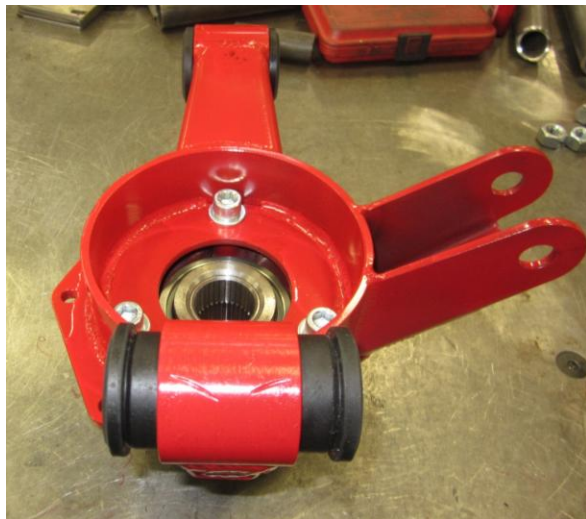

Figure 54



Figure 55

For questions on installations please call 800-841-8188 In Illinois (847) 487-0150



Apply grease to the splines of the CV joint axles. Install the stub axles into the bearing assemblies until the CV joint axle bottoms out against the hubs. Place the nut back onto the threads and DO NOT tighten. Raise the lower control arm and upright until the CV axle holes align with the holes of the spacer and the stub axles. Use the twelve M10 x 80mm long bolts and split lock washers to fully install the CV joint axle and rear brake rotor to the axle stub. Use thread locker on the M12 bolts. **Torque M12 bolts to 70 ft-lbs. See Figures 56-61.**



Figure 58



Figure 59

Next use the Cam adjuster bolts to attach the upper control arms to the uprights. Make sure the Cam bolt washers fit into the “C” shaped grooves welded on each side of the uprights. At this time you can also tighten the axle nut.



Cam Bolts, Figure 60



Cam Bolt installed, Figure 61

Then install the steering arms, placing the steel spacer on the rear side, and the two misalignment spacers on each end of the rod ends. Attach the steering arms to the main cradle and the uprights. **See figures 60, 61, 62.**

For questions on installations please call 800-841-8188 In Illinois (847) 487-0150



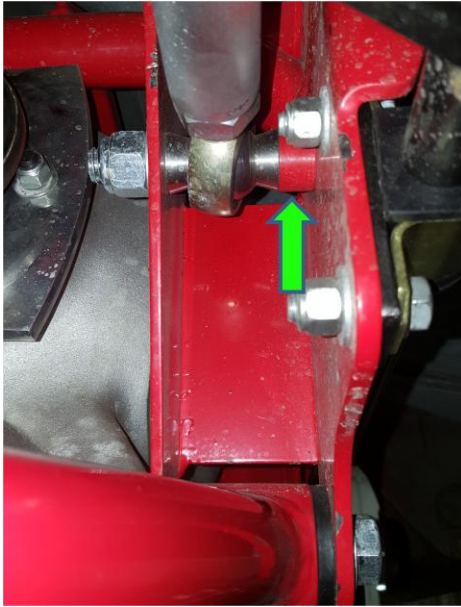

Drivers Side, Figure 62

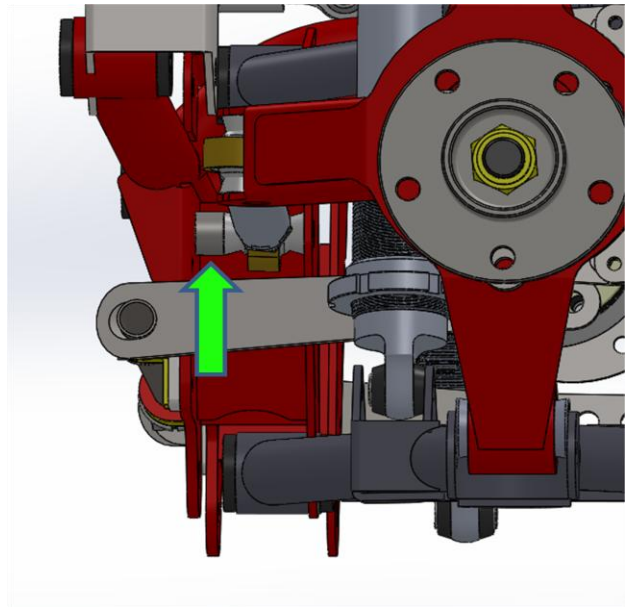

Passenger Side, Figure 63

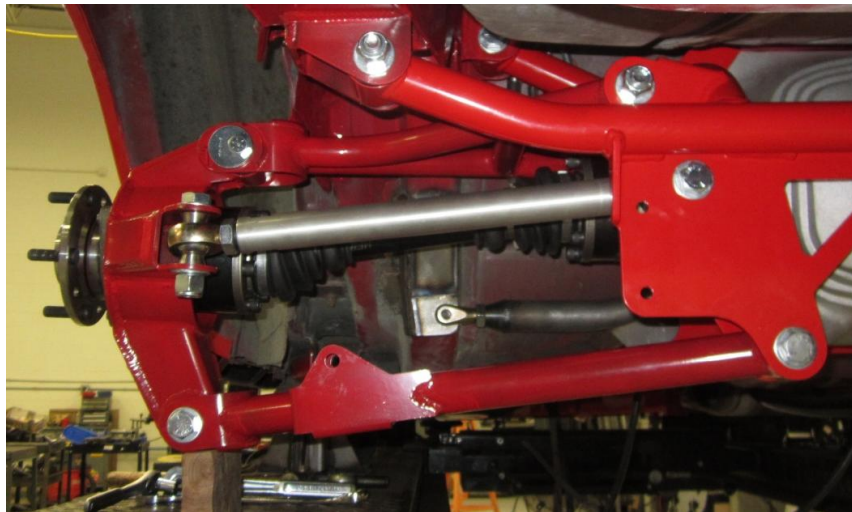

Drivers Side, Figure 64

Next assemble the rear coil over shocks. Mount the shocks with the adjuster knobs on the bottom to the lower control arms. Use the $\frac{1}{2}$ " x 2.75" long bolts, washers and nuts to mount the shocks, see **Figure 65 and 66**.

For questions on installations please call 800-841-8188 In Illinois (847) 487-0150



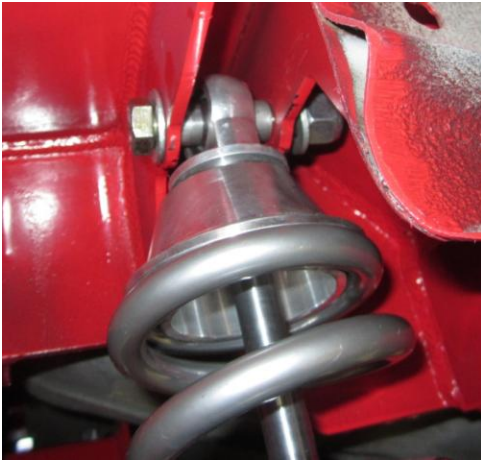

Figure 65

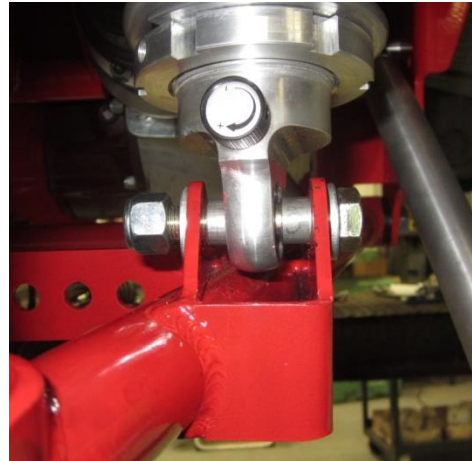

Figure 66

There are three different brake options that are available for the IRS. The first option includes: the C-4 Corvette calipers with integrated parking brake. The second option includes the Wilwood calipers, no parking brake. The third is option is the Wilwood brake calipers with mechanical parking brake caliper. Each option has its own brake caliper mount, make sure your kit has the correct mount.

Brake Option 1:

The following are instructions to install the C-4 calipers. Use the six 3/8"-16 x 1.25" button head screws, washers and nylock nuts. Fasten the brake caliper adapter to the outside side mount located on the front side of the uprights. **Torque the 3/8" bolts to 20 ft-lbs, see figure 67.** Next slide the rear rotors on over the wheel studs, then install the C-4 brake caliper brackets. Note the rear rotor are fastened though the clamping force of the lug nuts after you install the rear wheels. Use the four supplied M12x20mm Flange bolts to fasten the C-4 Caliper mount brackets to the adapter. **Torque bolts to 131 ft-lbs see figure 68.**

For questions on installations please call 800-841-8188 In Illinois (847) 487-0150



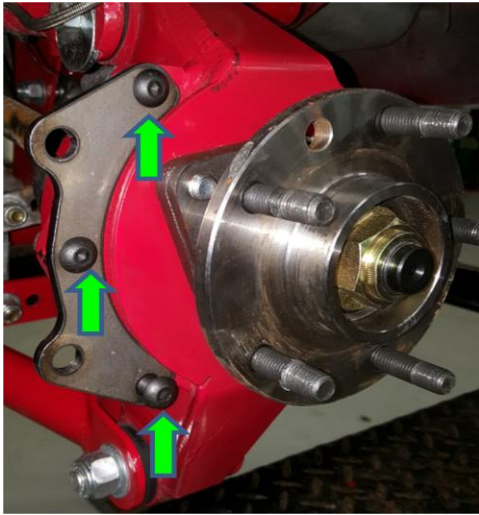

Brake Caliper Adapter, Fig. 67

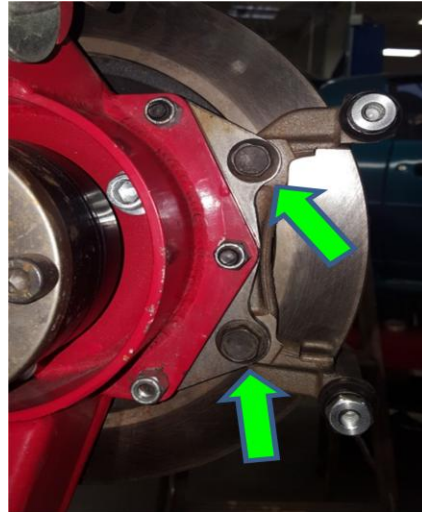

C-4 Brake Caliper Mount, Fig. 68

Install the brake pads as shown in **figure 69**, note the pad with the anti-rattle clip goes on the inside of the rotor. Next install the brake caliper, make sure that the two torsional springs on the pads are preloaded evenly against the underside of the brake caliper. Note the torsional springs hold the pads down into the caliper bracket and are necessary so the pads don't get knocked out of place and wear unevenly. Use the two M8x20mm long bolts to attach the brake caliper to the caliper pin sliders. We recommend you use thread locker on these bolts or safety wire the bolts so they don't come loose. **See figure 70.**

For questions on installations please call 800-841-8188 In Illinois (847) 487-0150





Figure 69



Figure 70

Brake Option 2:

The following instructions are for mounting Wilwood brake calipers. We recommend reading through the instructions that come with the Wilwood brake kit. First use the six supplied 3/8"-16 x 1.25" long button head screws, washers and nylock nuts to mount the caliper adapter to the outside side mount located on the uprights. **Torque these 3/8" bolts to 20 ft-lbs, see figure 67.**

Then slide the rear rotors on over the wheel studs. Next install the brake calipers, use the four 3/8"-24 x 1.25" long hex bolts, .063" thick washers and .032" shim washers to mount the calipers, to the caliper adapter bracket. Use the .032" shim washers to space the caliper it is positioned on center with the brake rotor. Use thread locker on the caliper bolts. Thread the bolts into the caliper brackets. Spread the end of the cotter pin in. **Torque bolts to 20 ft-lbs. See Figures 71, 72, 73 and 74.**

Reference the Wilwood instructions for correct caliper spacing diagram and verify the alignment is correct. Note each caliper adapter bracket should have two clinch nuts that are pressed into it. Make sure the clinch nuts are facing away from the center of the car. See the Wilwood instruction diagrams for more details. These instructions can also be found online if they are missing from your kit. Don't forget to slide in the brake pads and cotter pin and spread the cotter pin ends.

For questions on installations please call 800-841-8188 In Illinois (847) 487-0150





Figure 71



Figure 72



Figure 73

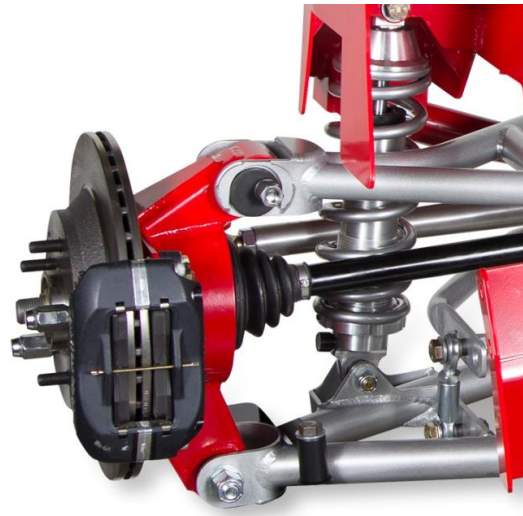

Figure 74

Option 3:

The third option uses both the Wilwood brake caliper and MC4 Mechanical parking brake. Both calipers mount on the same adapter bracket. Follow the instructions listed above in [Option 2](#) for mounting the brake calipers. Then refer to the Wilwood instructions for mounting MC4 parking brake calipers, see **figure 75**, pictures below.

For questions on installations please call 800-841-8188 In Illinois (847) 487-0150





MC4 Mechanical Parking Brake, Figure 75

2nd Brake Rotor Options

If you have the dimple drilled and slotted rotors, pay close attention to the arrow on the rotors. See **figure 76** below. The wide aperture slots on these brakes are designed to draw cool air under the brake pad and rotor interface and help cool the temperature of the brake pad during heavy braking.



Dimple Drilled & Slotted Rotor, Fig. 76

If you have the Spec 37 Rotors look for the small directional arrow located on the inside of the rotor and mount accordingly, **see figure 77**. When attaching the C-4 brake hat to the rotor use removable thread locker on the 5/16-18 button head Torx head screws. Follow the recommended break in procedure provided in Wilwood instructions.

For questions on installations please call 800-841-8188 In Illinois (847) 487-0150



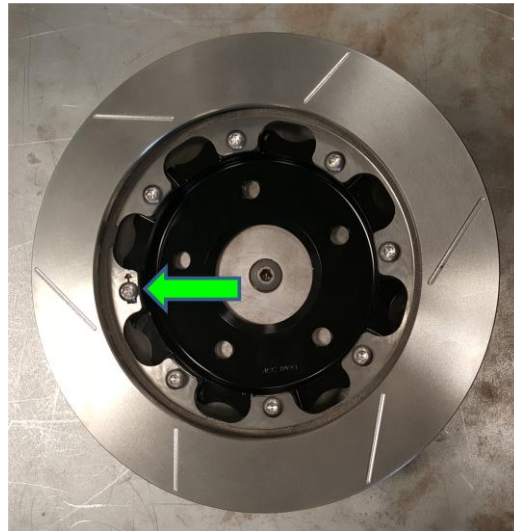

Wilwood GT 36 Curved Vane Spec-37 Rotors, Figure 77

Next you want to route the brake lines, depending on which options you have you will need to bend your stock brake lines and possibly add an extension or T-block. These parts should be available at your local auto parts store. After you have routed your brake lines bleed the brakes with a high quality brake fluid. Verify the brake lines and cables are secured down and away from any heat sources, rub/ wear points or pinch points in the suspension.

Now on to the rear sway bar, mount the sway bar bushing and brackets on the bar. Use the two rectangular sway bar spacers in between the cradle and the sway bar mounts. Use the four 3/8"-16 x 1.25" long hex bolts, 3/8" AN washers and 3/8" Nylock nuts to attach the sway bar mounts to the rear of the main cradle. **Torque the four 3/8" bolts to 20 ft-lbs, see figure 79.**



Rear Sway Bar, Figure 79

For questions on installations please call 800-841-8188 In Illinois (847) 487-0150



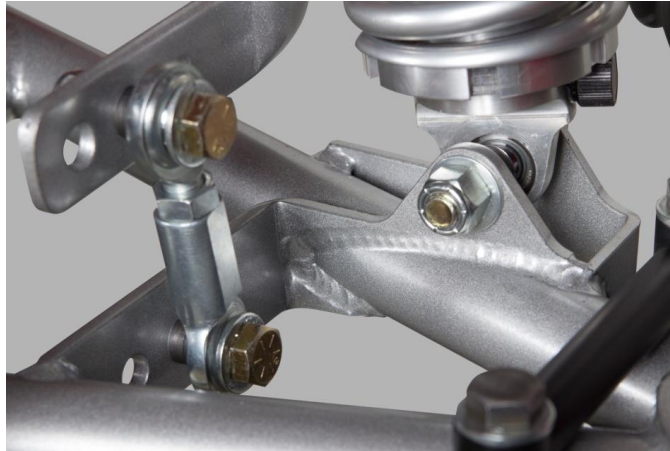

Sway Bar, Spherical Bearing Rod End links, Figure 80

Assemble the spherical bearing rod end links as shown in **figure 80**. There are three pairs of holes that can be used to change the rear sway bar rate. Move the link toward the front of the car softens the sway bar rate. Moving the rod end rearward stiffens the sway bar rate. Note you can vary the left and right side to get in between rates for a total of six different bar rates, one being the disconnected, i.e. no rate.

Next install the drive shaft. We suggest at this point you snug down any bolts or nuts that may have been left loose in the prior steps.

Finally, you are ready to set the alignment of your vehicle. Be sure to do so with the arms and shocks set at ride height (the lower control arms should be 1 to 2 degree going downhill towards the wheels). You may want to take you car to an alignment shop for an alignment. If you have a digital angle finder and toe plate and want to align it yourself it's pretty easy. Start by loosen the cam bolt adjuster nut located in the top upright adjuster to set camber. The cam bolts are on eccentric cams, so when the bolts are rotated about the center, the cams will tilt the upright and very your camber. When you achieve your desired camber setting; tighten the cam nut assembly down to lock the setting in place. Just be sure that both sides have equal camber settings, or the car will tend to pull to one side and have uneven tire wear.

To set the vehicle toe, loosen up the jam nut on each side of the steering arm. Turn the steering arm to set the toe to the specification below. Use the machined flats on steering arms to lengthen or shorten the link. When you achieve your desired toe setting, lock both jam nuts down while holding the steering arm across the machined flats.

For questions on installations please call 800-841-8188 In Illinois (847) 487-0150



Here are the recommended alignment specifications:

Alignment Specifications:

Camber: 0° - .5° Negative

Toe: 0 - 1/16 Toe-In

Since you are now to the point where you have a finished, and hopefully have a running car, it is time to test drive it. After a few hundred miles, re-torque all the fasteners and double check the ride height and the alignment. The springs may have settled, which would change the ride height and the camber setting. Readjust the ride height first before changing the alignment. After this initial setting period, the springs and bushings should have pretty much taken their final set, so you should be on your way to many miles of cruising in style.

3rd Gen Camaro Wheel offsets:

- Front 9" width, 5" Backspacing on 265/ 275 Tire
- Front 9.5" width, 5.5" Backspacing 265 /275 Tire
- Rear 9.5" width, Backspacing 5.5", 275/ 285 Tire
- Rear 10.0" width, Backspacing 6.0", 275/ 285 Tire

For questions on installations please call 800-841-8188 In Illinois (847) 487-0150

